



OXY5741A

Rugged Open-Standard EBX SBC

Expansion, Extend Temperature

-40 to 85°C

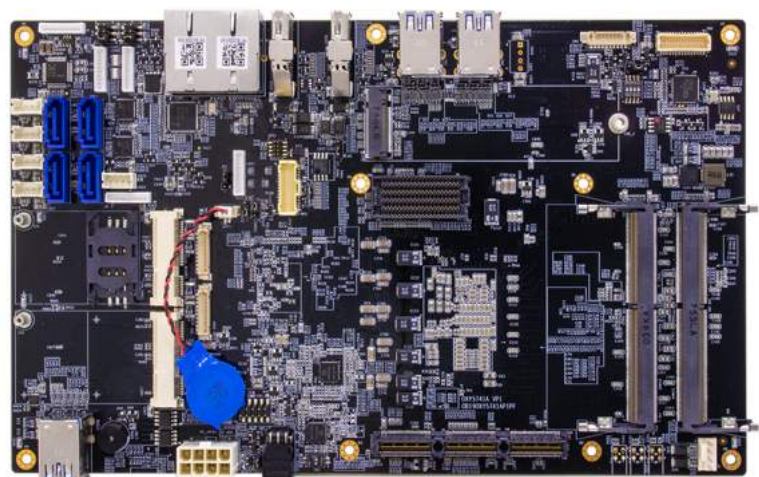

User's Manual

Revision Date: Mar. 10. 2023

Safety Information

Electrical safety

- To prevent electrical shock hazard, disconnect the power cable from the electrical outlet before relocating the system.
- When adding or removing devices to or from the system, ensure that the power cables for the devices are unplugged before the signal cables are connected. If possible, disconnect all power cables from the existing system before you add a device.
- Before connecting or removing signal cables from the motherboard, ensure that all power cables are unplugged.
- Seek professional assistance before using an adapter or extension cord. These devices could interrupt the grounding circuit.
- Make sure that your power supply is set to the correct voltage in your area.
- If you are not sure about the voltage of the electrical outlet you are using, contact your local power company.
- If the power supply is broken, do not try to fix it by yourself. Contact a qualified service technician or your local distributor.

Operation safety

- Before installing the motherboard and adding devices on it, carefully read all the manuals that came with the package.
- Before using the product, make sure all cables are correctly connected and the power cables are not damaged. If you detect any damage, contact your dealer immediately.
- To avoid short circuits, keep paper clips, screws, and staples away from connectors, slots, sockets and circuitry.
- Avoid dust, humidity, and temperature extremes. Do not place the product in any area where it may become wet.
- Place the product on a stable surface.
- If you encounter any technical problems with the product, contact your local distributor

Statement

- All rights reserved. No part of this publication may be reproduced in any form or by any means, without prior written permission from the publisher.
- All trademarks are the properties of the respective owners.
- All product specifications are subject to change without prior notice.

OXY5741A User's Manual

Revision Date: Mar. 10. 2023

Revision History

Revision	Date (yyyy/mm/dd)	Changes
V1.0	2021/04/22	First release
V1.1	2021/05/27	Add Mechanical Dimensions
V1.2	2021/9/10	Modify DIO Pin Define
V1.3	2021/12/7	Typesetting modification
V1.4	2022/11/24	Add COM1/COM2 RS422/RS485 Pin define
V1.5	2023/03/10	Remove LED

Packing List

Item	Description	Q'ty
1	OXY5741A EBX SBC	1
2	CD(Driver + User's manual)	1



If any of the above items is damaged or missing, please contact your local distributor.

RoHS Compliance



Perfectron RoHS Environmental Policy and Status Update

Perfectron is a global citizen for building the digital infrastructure. We are committed to providing green products and services, which are compliant with European Union RoHS (Restriction on Use of Hazardous Substance in Electronic Equipment) directive 2011/65/EU, to be your trusted green partner and to protect our environment.

In order to meet the RoHS compliant directives, Perfectron has established an engineering and manufacturing task force to implement the introduction of green products. The task force will ensure that we follow the standard Perfectron development procedure and that all the new RoHS components and new manufacturing processes maintain the highest industry quality levels for which Perfectron are renowned.

The model selection criteria will be based on market demand. Vendors and suppliers will ensure that all designed components will be RoHS compliant.

Table of Contents

Safety Information	1
Electrical safety	1
Operation safety	1
Statement	1
Revision History	2
Packing List	2
RoHS Compliance	3
Chapter 1 : Product Introduction	7
1.1 Specifications.....	7
1.2 Block Diagram	11
1.3 Board Placement.....	12
1.4 Mechanical Dimensions	13
Chapter 2 : Jumpers and Connectors Location	14
2.1 Jumpers and connectors list	14
2.2 Jumper Settings	15
Chapter 3: AMI BIOS UTILITY	24
3.1 Starting	24
3.3 Main Menu.....	24
3.4 Advanced Menu	26
3.4.1 CPU Configuration.....	27
3.4.2 Power & Performance	28
3.4.4 AMT Configuration.....	30
3.4.4.1 CIRA Configuration	31
3.4.4.2 ASF Configuration	31
3.4.4.3 Secure Erase Configuration.....	32
3.4.4.4 OEM Flags Settings	33

3.4.4.5 MEBx Resolution Settings.....	34
3.4.5 Trusted Computing.....	36
3.4.6 ACPI Settings.....	38
3.4.7 IT8786 Super IO Configuration.....	39
3.4.7.1 Social Port 1 Configuration.....	39
3.4.7.2 Social Port 2 Configuration.....	40
3.4.8 Hardware Monitor.....	41
3.4.8.1 Smart Fan Function.....	41
3.4.8.2 System Fan Setting.....	42
3.4.9 PCI Subsystem Settings.....	43
3.4.10 USB Configuration.....	44
3.4.11 CSM Configuration.....	45
3.4.12 NVMe Configuration.....	46
3.4.13 Network Stack Configuration.....	47
3.5.1 System Agent (SA) Configuration.....	48
3.5.2 PCH-IO Configuration.....	51
3.5.2.1 PCI Express Configuration.....	51
3.5.2.2 SATA And RST Configuration.....	53
3.5.2.3 Security Configuration.....	55
3.6.1 Administrator Password.....	57
3.6.2 User Password.....	58
3.6.3 Secure Boot.....	58
3.6.3.1 Restore Factory Keys.....	59
3.6.3.2 Key Management.....	59
3.6.3.3 Install factory defaults.....	60
3.6.3.4 File System.....	60
3.6.3.5 File System.....	61

3.6.3.6 Restore DB defaults	61
3.6.3.7 Platform Key(PK).....	62
3.6.3.8 Key Exchange Kesys	62
3.6.3.9 Authorized Signatures	63
3.6.3.10 Forbidden Signatures	63
3.6.3.11 Authorized TimeStamps.....	64
3.6.3.12 OsRecovery Signatures	64
3.7 Boot.....	65
3.8 Save & Exit.....	66
3.8.1 Save Changes and Exit	66
3.8.2 Exit Without Saving	67
3.8.3 Save & reset	67
3.8.4 Reset Without Saving.....	68
3.8.5 Save Setup Values	68
3.8.6 Load Previous Values	69
3.8.7 Load Optimized Defaults	69
3.8.8 Save Values as User Defaults	70
3.8.9 Restore User Defaults.....	70

Chapter 1 : Product Introduction

1.1 Specifications

System

CPU	Intel® Core™ i7-9850HE (6 Cores/12 Threads,9M Cache,up to 4.40GHz),45W Intel® Core™ i7-9850HL (6 Cores/12 Threads,9M Cache,up to 4.10GHz), 25W Intel® XEON® E-2276ME (6 Cores/12 Threads,12M Cache,up to 4.50GHz),45W Intel® XEON® E-2276ML (6 Cores/12 Threads,12M Cache,up to 4.20GHz),25W Intel® Core™ i5-8400H (6 Cores/12 Threads,8M Cache,up to 4.20GHz),45W
Memory type	4 x 260 Pin DDR4 2666MHz SO-DIMM (up to 128GB, XEON® SKU support ECC)
Chipset	CM246
BIOS Code	AMI UEFI BIOS
BIOS Flash	SPI Flash
Super I/O	ITE 8786
TPM	TPM2.0(SLB9665)
iAMT	iAMT12.0
WatchDog	1-255 sec. or 1-255 min. software programmable and can be generate system reset

Display

Chipset	Intel® UHD Graphics 630
LVDS	Dual channel 24-bit LVDS, max resolution up to 1920 x 1080 @ 60Hz
Display Port	Up to 4096 x 2304 @ 60Hz
Multi-Display	Triple simultaneous displays with 48-bit LVDS+DP

Audio

Codec	ALC888S
-------	---------

Expansion

OXY5741A User's Manual

Revision Date: Mar. 10. 2023

M.2	1 x M.2(M-key, Type : 2280, SATA/PCIe 3.0 x 4 NVMe)
Mini PCIe	2 x Full size (USB / PCIe and 1 x micro SIM Card)
PCIe/104	1 x TYPE2
FPE	1
Ethernet	
Chipset	Intel® I210 & I219LM GbE LAN(10/100/1000 Mbps support)
WOL	Yes
Boot from LAN	Yes for PXE
Rear I/O	
Display Port	2
USB 3.0	4 x USB3.0
LAN	2
Front I/O	
PW Button	1
USB	2 x USB 3.0
Internal I/O	
USB2.0	4
GPIO	1(4in/4out)
SATAIII	4 (0,1,5 RAID)
SATA Power	4
DP	1
Audio	1 (Line-out / Mic-in)
Serial	2 (RS-232/422/485 autoflow control)
DC connector	1
LVDS Inverter	1
LVDS connector	1
LPC	1
CPU FAN	1
Front Panel	Power LED, HD LED, Reset, Power Switch, Buzzer

OXY5741A User's Manual

Revision Date: Mar. 10. 2023

Control

Mechanical and Environmental

Form Factor	EBX
Dimension	146mm x 243mm
Power Type	DC-IN 12V
Power Consumption	180W
Operation Temperature	-40 to 85°C
Storage Temperature	-40 to 85°C
Relative Humidity	10% to 90%, non-condensing

Standard Compliance

Standart Compliance	CE / FCC
---------------------	----------

OS

OS Support	Windows®10 64-bit Linux(Support by request)
------------	--

Modular Architecture

PCIe/104 Bus	PCIe/104 (PCIe v3.0, Type 2) bus – Two Gen3.0 x 4 lanes plus quad Gen 3.0 x1 lanes. Supports integration with stackable PCIe/104 and/or PCI/104-Express I/O cards. PCI-PCIe bridge adapter required to support PCI-104 and/or PC/104-Plus IO cards.rds
FPE	FPE B2B connector to support PCIe Gen3.0 x16 lanes Use this feature configures the PCI-E port Bifurcation setting for a PCI-E port Specified by the user. The options are x8x4x4, x8x8 and x16 (SK229) 3 card slots available for PCIe/104 or PCIe adapter cards example : <ol style="list-style-type: none">(1) FPE/PCIe104 to 4 mini SAS connectors (SK229)(2) Mini SAS to PCIe x16 slot (x8 signal (SK228)(3) Mini SAS to PCIe x16 slot (x16 signal (SK226/SK230)(4) Mini SAS to MXM adapter board (SK224)
Mini PCI/e	2 x Full size mini PCIE slot <ol style="list-style-type: none">(1) 1 x slot dedicated for Mini-PCIe card I/O module (i.e. MIL-STD-1553,

OXY5741A User's Manual

Revision Date: Mar. 10. 2023

	ARINC 429, serial, Ethernet, GPS, etc.) (2) 1 x slot auto-detectable mSATA storage or Mini-PCle card I/O (3) 60+ pins available on DTL-38999 for Mini-PCle I/O signals
M.2	M.2 2280 slot to support PCIe Gen3.0 x4 or NVME SSD storage device by jumper setting.
Expansion I/O Support	5 to 6 card slots available for PCIe/104 or PCI/104-Express cards example : (1) HDSDI/PAL/NTSC H.264 frame grabber (mPCle by SK401) (2) H.264 video recorder/network streaming card, (mPCle by SK401) (3) MIL-STD-1553 /ARINC429 (mPCle by SK401) (4) CAN data-bus module (mPCle by SK401) (5) Ethernet NIC / 10GbE LAN switch (SK506 ; SK502)
Data Storage	4 x SATA controllers for SATA 3.0 and 1 x NVME SSD can support Data Storage function (1) SATA LAN 0 (2) SATA LAN 1 (3) SATA LAN 2 (4) SATA LAN 3 (5) M.2 2280 NVMe SSD

1.2 Block Diagram

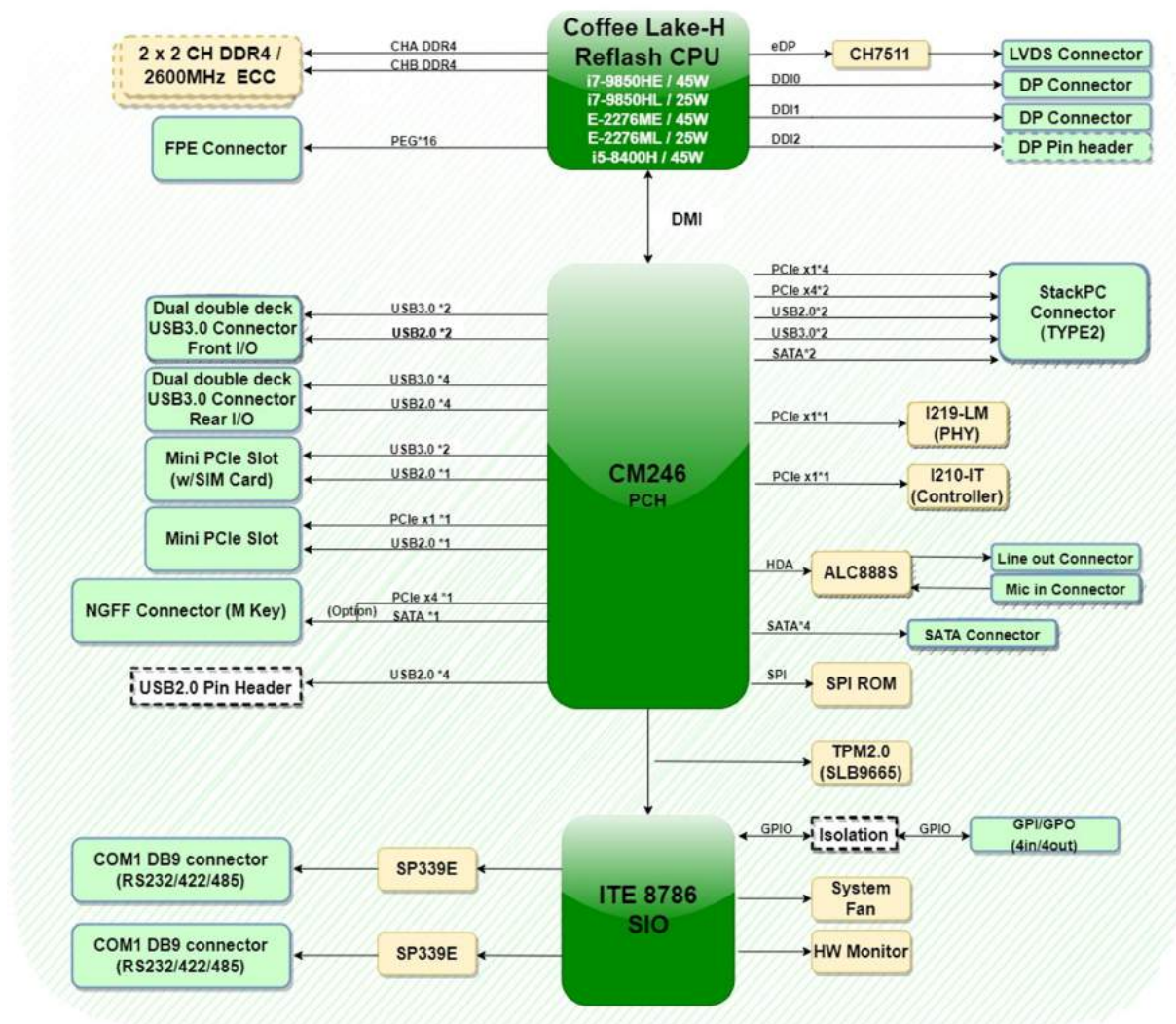

OXY5741A User's Manual

Revision Date: Mar. 10. 2023

1.3 Board Placement

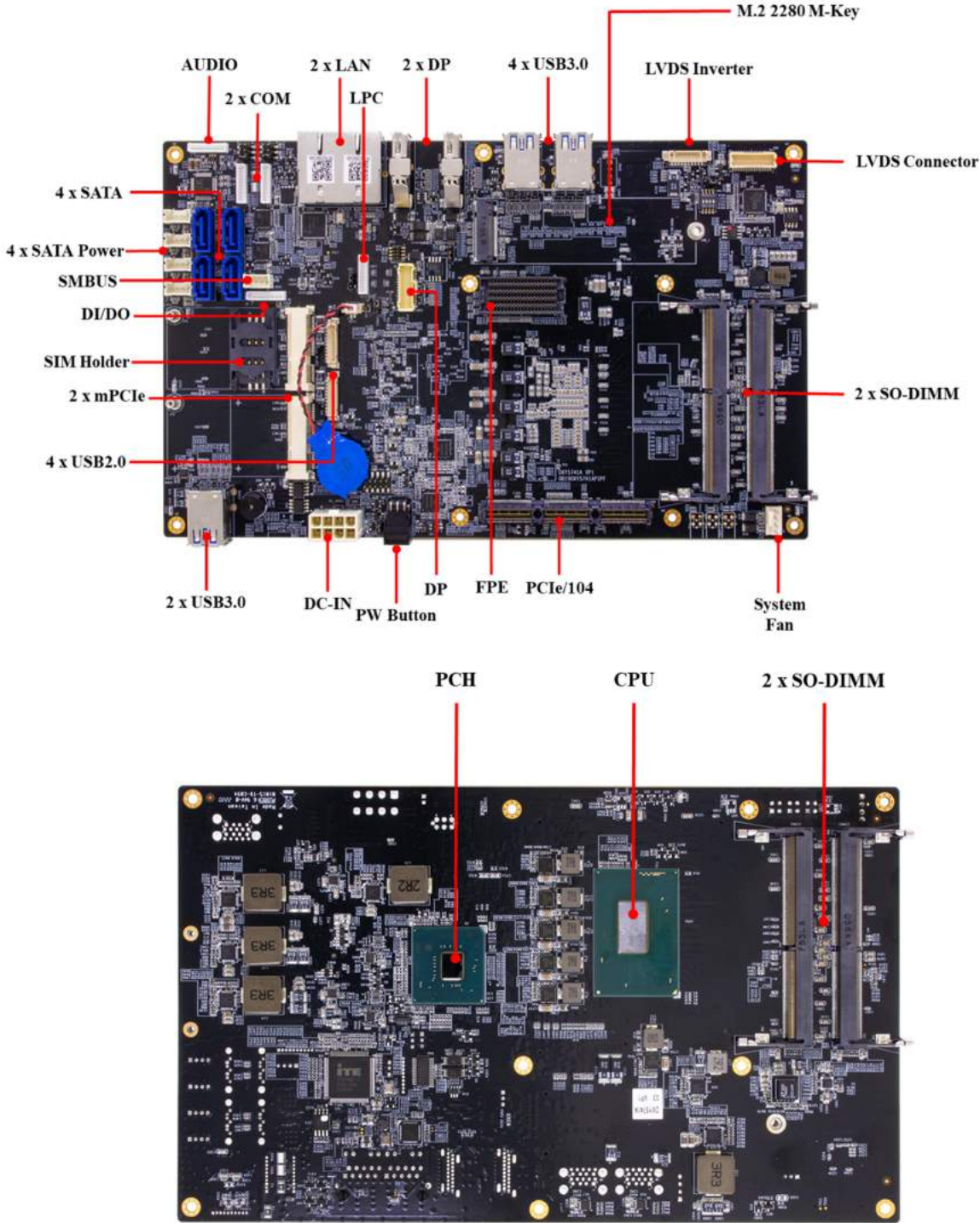

OXY5741A User's Manual

Revision Date: Mar. 10. 2023

1.4 Mechanical Dimensions

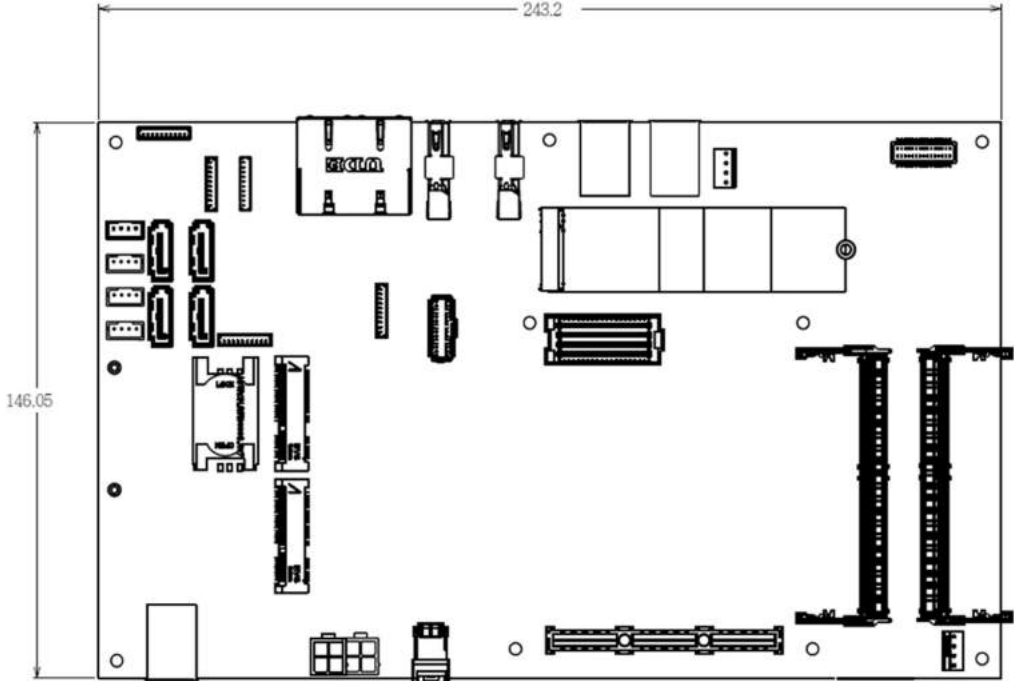

Chapter 2 : Jumpers and Connectors Location

2.1 Jumpers and connectors list

Label	Function
BAT1	BATTERY connector
CN1	Inverter connector
CN10/CN12/CN14/CN16	SATA Power
CN17	LPC connector (Update BIOS)
CN19	SMBUS
CN2	LVDS Connector
CN6/CN7	USB2.0 (Total 4 Port)
CN8	M.2 M KEY Connector
CN9/CN11/CN13/CN15	Serial SATA Connectors
DC_JACK1	ATX12V DC connector
DIMM0	DDR4 SO DIMM Socket
DIMM1	DDR4 SO DIMM Socket
DIMM2	DDR4 SO DIMM Socket
DIMM3	DDR4 SO DIMM Socket
DP3	DISPLAY PORT HEADER
FP1	Front Panel
FPE1	FPE Top connector
J1	Front side MIC-In/ Line-Out Connector
J2	Digital I/O Box Head
J3	RS232/422/485 with 5V/12V selectable
J4	RS232/422/485 with 5V/12V selectable
J5	System Fan connector
JCMOS1	ME Flash Security
JCMOS2	RTC Reset
JM2	M.2 Signal select
JP1	LVDS_VDD select
JP3	COM1 +12/+5V selection
JP4	COM2 +12/+5V selection
JP5	AT/ATX Mode
MCARD1	Mini PCIE Card Slot<Full size Co-lay mSATA>
MCARD2	Mini PCIE Card Slot<Full size Co-lay mSATA>
SIM_CARD1	SIM card socket

OXY5741A User's Manual

Revision Date: Mar. 10. 2023

STACKPC1	PCIe/104 connector
SW1	LVDS Resolution selection
SW2	Power Button
SW3	PCIE CFG[5:6]

2.2 Jumper Settings

CN1: Inverter connector

PIN	DEFINITION
1	12V
2	12V
3	12V
4	5VS
5	5VS
6	GND
7	GND
8	BL_EN
9	LVDS_BKL_CTRL
10	GND

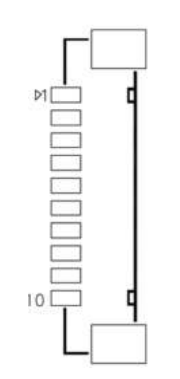

CN2: LVDS Connector

PIN	DEFINITION	PIN	DEFINITION
1	LVDS_BCLK	2	GND
3	LVDS_BCLK#	4	LVDS_A3
5	GND	6	LVDS_A3#
7	LVDS_B3	8	GND
9	LVDS_B3#	10	LVDS_ACLK
11	LVDS_B2	12	LVDS_ACLK #
13	LVDS_B2#	14	GND
15	LVDS_B1	16	LVDS_A2
17	LVDS_B1#	18	LVDS_A2#
19	LVDS_B0	20	LVDS_A1
21	LVDS_B0#	22	LVDS_A1#
23	GND	24	LVDS_A0
25	LVDS_DCC_SC	26	LVDS_A0#
27	LVDS_DCC_SD	28	GND
29	+VDD_LVDS	30	+VDD_LVDS

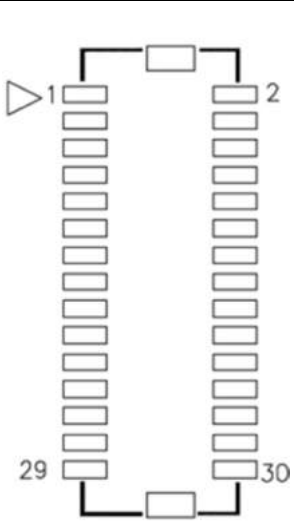

OXY5741A User's Manual

Revision Date: Mar. 10. 2023

CN7: USB2.0 Pin Header

PIN	DEFINITION
1	+USB2_VCC9
2	USB2_N9_C
3	USB2_P9_C
4	GND
5	GND
6	+USB2_VCC10
7	USB2_N10_C
8	USB2_P10_C
9	GND
10	GND

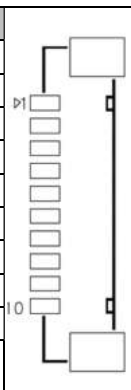

CN9/CN11/CN13/CN15: Serial SATA Connectors

PIN	DEFINITION
1	GND
2	TXP
3	TXN
4	GND
5	RXN
6	RXP
7	GND

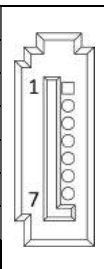

CN10/CN12/CN14/CN16: SATA POWER Connector

PIN	DEFINITION
1	12V
2	GND
3	GND
4	5VS

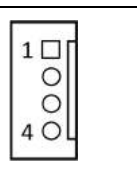

DC_JACK1: DC-IN

PIN	DEFINITION	PIN	DEFINITION
1	GND	2	GND
3	GND	4	GND
5	+12VSB	6	+12VSB
7	+12VSB	8	+12VSB

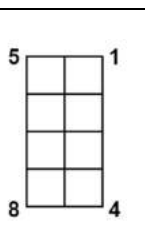

OXY5741A User's Manual

Revision Date: Mar. 10. 2023

CN17: LPC connector

PIN	DEFINITION
1	GND
2	INT_SERIRQ
3	3V3
4	LPC AD0
5	LPC AD1
6	LPC AD2
7	LPC AD3
8	LPC FRAME#
9	CHIP_PLTRST#
10	C_LPC_CLK_SIO



DP3: DISPLAY PORT HEADER

PIN	DEFINITION	PIN	DEFINITION
1	GND	2	GND
3	DDI3_TXP0_DP_C	4	NC
5	DDI3_TXN0_DP_C	6	NC
7	DDI3_TXP1_DP_C	8	NC
9	DDI3_TXN1_DP_C	10	NC
11	DDI3_TXP2_DP_C	12	NC
13	DDI3_TXN2_DP_C	14	NC
15	DDI3_TXP3_DP_C	16	NC
17	DDI3_TXN3_DP_C	18	NC
19	DDI3_AUX_P_C	20	NC
21	DDI3_AUX_N_C	22	NC
23	GND	24	GND
25	DDI3_DDC_AUX_SEL	26	NC
27	DP3_DET	28	NC
29	DP3_PWR	30	NC

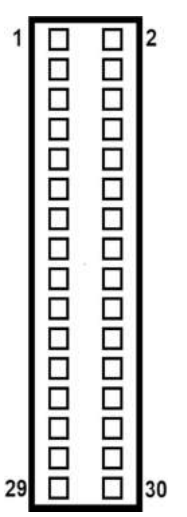

FP1: Front Panel

PIN	DEFINITION	PIN	DEFINITION
1	FP_HDLED+	2	FP_PLED+
3	HDLED-	4	GND
5	GND	6	PANSWIN#
7	EXT_RESET#	8	GND
9	NC	10	NC



OXY5741A User's Manual

Revision Date: Mar. 10. 2023

FPE1: FPE Top Connector

PIN	DEFINITION	PIN	DEFINITION	PIN	DEFINITION	PIN	DEFINITION	PIN	DEFINITION
1	NC	2	NC	3	GND	4	3V3	5	GND
11	GND	12	NC	13	GND	14	NC	15	GND
21	NC	22	NC	23	NC	24	GND	25	NC
31	NC	32	NC	33	NC	34	NC	35	NC
41	GND	42	NC	43	GND	44	NC	45	GND
51	NC	52	GND	53	NC	54	GND	55	NC
61	NC	62	NC	63	NC	64	NC	65	NC
71	GND	72	NC	73	GND	74	NC	75	GND
81	PEG_TXP0	82	NC	83	PEG_TXP2	84	GND	85	PEG_TXP4
91	PEG_TXN0	92	PEG_TXP1	93	PEG_TXN2	94	PEG_TXP3	95	PEG_TXN4
101	GND	102	PEG_TXN1	103	GND	104	PEG_TXN3	105	GND
111	PEG_RXP_0	112	GND	113	PEG_RXP_2	114	GND	115	PEG_RXP_4
121	PEG_RXN_0	122	PEG_RXP_1	123	PEG_RXN_2	124	PEG_RXP_3	125	PEG_RXN_4
131	GND	132	PEG_RXN_1	133	GND	134	PEG_RXN_3	135	GND
141	PEG_TXP8	142	GND	143	PEG_TXP10	144	GND	145	PEG_TXP12
151	PEG_TXN8	152	PEG_TXP9	153	PEG_TXN10	154	PEG_TXP11	155	PEG_TXN12
161	GND	162	PEG_TXN9	163	GND	164	PEG_TXN11	165	GND
171	PEG_RXP_8	172	GND	173	PEG_RXP_10	174	GND	175	PEG_RXP_12
181	PEG_RXN_8	182	PEG_RXP_9	183	PEG_RXN_10	184	PEG_RXP_11	185	PEG_RXN_12
191	GND	192	PEG_RXN_9	193	GND	194	PEG_RXN_11	195	GND

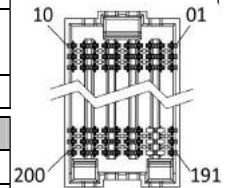

PIN	NAME	PIN	NAME	PIN	NAME	PIN	NAME	PIN	NAME
6	3V3SB	7	GND	8	5VSB	9	5V	10	+12V
16	NC	17	GND	18	NC	19	5V	20	+12V
26	GND	27	NC	28	GND	29	5V	30	+12V
36	NC	37	NC	38	NC	39	NC	40	+12V
46	NC	47	GND	48	NC	49	GND	50	+12V
56	GND	57	NC	58	GND	59	GND	60	+12V
66	NC	67	NC	68	NC	69	GND	70	+12V
76	NC	77	GND	78	NC	79	GND	80	+12V
86	GND	87	PEG_TXP6	88	GND	89	GND	90	+12V
96	PEG_TXP5	97	PEG_TXN6	98	PEG_TXP7	99	GND	100	NC
106	PEG_TXN5	107	GND	108	PEG_TXN7	109	GND	110	IO_PLTRST#
116	GND	117	PEG_RXP_6	118	GND	119	PEG_A_CLK_P5	120	GND
126	PEG_RXP_5	127	PEG_RXN_6	128	PEG_RXP_7	129	PEG_A_CLK_N5	130	FPE_BUS_ERR#
136	PEG_RXN_5	137	GND	138	PEG_RXN_7	139	GND	140	3V3SB
146	GND	147	PEG_TXP14	148	GND	149	PEG_B_CLK_P6	150	GND
156	PEG_TXP13	157	PEG_TXN14	158	PEG_TXP15	159	PEG_B_CLK_N6	160	GND
166	PEG_TXN13	167	GND	168	PEG_TXN15	169	GND	170	NC
176	GND	177	PEG_RXP_14	178	GND	179	NC	180	+12V
186	PEG_RXP_13	187	PEG_RXN_14	188	PEG_RXP_15	189	3V3	190	+12V
196	PEG_RXN_13	197	GND	198	PEG_RXN_15	199	3V3	200	+12V

J1 : Audio Box Head

PIN	DEFINITION
1	GND
2	MIC1_JD
3	MIC1_R
4	MIC1_L
5	FRONT_JD
6	FRONT_R
7	FRONT_L
8	NC
9	NC
10	NC



J2: Digital I/O Box Head

PIN	DEFINITION
1	DIO0(Input)
2	DIO1(Input)
3	DIO2(Input)
4	DIO3(Input)
5	DIO4(Output)
6	DIO5(Output)
7	DIO6(Output)
8	DIO7(Output)
9	3V3
10	GND



J3: RS232/422/485 Box Head

PIN	RS232	RS422	RS485
1	5V	NC	NC
2	GND	GND	GND
3	COM1P9SEL	NC	NC
4	COM1_DTR-	RX-	NC
5	COM1_CTS-	NC	NC
6	COM1_TXD-	RX+	NC
7	COM1_RTS-	NC	NC
8	COM1_RXD-	TX+	Data+
9	COM1_DSR-	NC	NC
10	COM1_DCD-	TX-	Data-



OXY5741A User's Manual

Revision Date: Mar. 10. 2023

J4: RS232/422/485 Box Head

PIN	RS232	RS422	RS485
1	5V	NC	NC
2	GND	GND	GND
3	COM2P9SEL	NC	NC
4	COM2_DTR-	RX-	NC
5	COM2_CTS-	NC	NC
6	COM2_TXD-	RX+	NC
7	COM2_RTS-	NC	NC
8	COM2_RXD-	TX+	Data+
9	COM2_DSR-	NC	NC
10	COM2_DCD-	TX-	Data-



J5: SYSTEM FAN Connector

PIN	DEFINITION
1	SYSTEMFAN_PWN
2	SYSTEMFAN_IO
3	+12V
4	GND

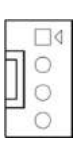

JCMOS1: ME Flash Security

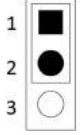
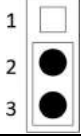
Jumper	Function description	Setting
1-2	ME Lock	
2-3	ME Unlock	

Default setting: 1-2

JCMOS2: RTC Reset

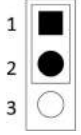
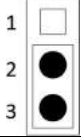
Jumper	Function description	Setting
1-2	Default	
2-3	Clear CMOS	

Default setting: 1-2

OXY5741A User's Manual

Revision Date: Mar. 10. 2023

JM2: M.2 Signal select

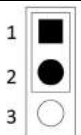
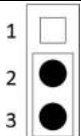
Jumper	Function description	Setting
1-2	PCIe	
2-3	SATA	
Default setting:1-2		

JP1: LVDS_VDD select

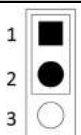
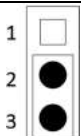
Jumper	Function description	Setting
1-2	3.3V	
2-3	5V	
Default setting: 1-2		

JP3: COM1 5V/12V selection

PIN	DEFINITION	PIN	DEFINITION
1	RI1#_OPTO	2	COM1P9SEL
3	5V	4	COM1P9SEL
5	+12V	6	COM1P9SEL

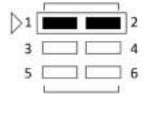

Default :1-2

JP4: COM2 5V/12V selection

PIN	DEFINITION	PIN	DEFINITION
1	RI1#_OPTO	2	COM2P9SEL
3	5V	4	COM2P9SEL
5	12V	6	COM2P9SEL

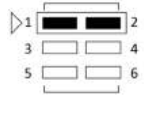



Default :1-2

OXY5741A User's Manual

Revision Date: Mar. 10. 2023

JP5 : AT/ATX Mode Selection(Default ATX)

Jumper	Function description	Setting
Non-Put	ATX	
1-2	AT	

Default setting: 1-2

STACKPC1: CONNECTOR A TOP

PIN	DEFINITION	PIN	DEFINITION	PIN	DEFINITION	PIN	DEFINITION	PIN	DEFINITION	PIN	DEFINITION
1	USB_OC#	2	PE_RST#	53	STK0/WAKE#	54	STK1/PEG_ENA#	105	STK2/SDVO_DAT	106	SDVO_CLK
3	3V3	4	3V3	55	GND	56	GND	107	GND	108	GND
5	USB_1p	6	USB_0p	57	PEx16_0T(8)p	58	PEx16_0T(0)p	109	PEx16_0R(8)p	110	PEx16_0R(0)p
7	USB_1n	8	USB_0n	59	PEx16_0T(8)n	60	PEx16_0T(0)n	111	PEx16_0R(8)n	112	PEx16_0R(0)n
9	GND	10	GND	61	GND	62	GND	113	GND	114	GND
11	PEx1_1Tp	12	PEx1_0Tp	63	PEx16_0T(9)p	64	PEx16_0T(1)p	115	PEx16_0R(9)p	116	PEx16_0R(1)p
13	PEx1_1Tn	14	PEx1_0Tn	65	PEx16_0T(9)n	66	PEx16_0T(1)n	117	PEx16_0R(9)n	118	PEx16_0R(1)n
15	GND	16	GND	67	GND	68	GND	119	GND	120	GND
17	PEx1_2Tp	18	PEx1_3Tp	69	PEx16_0T(10)p	70	PEx16_0T(2)p	121	PEx16_0R(10)p	122	PEx16_0R(2)p
19	PEx1_2Tn	20	PEx1_3Tn	71	PEx16_0T(10)n	72	PEx16_0T(2)n	123	PEx16_0R(10)n	124	PEx16_0R(2)n
21	GND	22	GND	73	GND	74	GND	125	GND	126	GND
23	PEx1_1Rp	24	PEx1_0Rp	75	PEx16_0T(11)p	76	PEx16_0T(3)p	127	PEx16_0R(11)p	128	PEx16_0R(3)p
25	PEx1_1Rn	26	PEx1_0Rn	77	PEx16_0T(11)n	78	PEx16_0T(3)n	129	PEx16_0R(11)n	130	PEx16_0R(3)n
27	GND	28	GND	79	GND	80	GND	131	GND	132	GND
29	PEx1_2Rp	30	PEx1_3Rp	81	PEx16_0T(12)p	82	PEx16_0T(4)p	133	PEx16_0R(12)p	134	PEx16_0R(4)p
31	PEx1_2Rn	32	PEx1_3Rn	83	PEx16_0T(12)n	84	PEx16_0T(4)n	135	PEx16_0R(12)n	136	PEx16_0R(4)n
33	GND	34	GND	85	GND	86	GND	137	GND	138	GND
35	PEx1_1Clkp	36	PEx1_0Clkp	87	PEx16_0T(13)p	88	PEx16_0T(5)p	139	PEx16_0R(13)p	140	PEx16_0R(5)p
37	PEx1_1Clkn	38	PEx1_0Clkn	89	PEx16_0T(13)n	90	PEx16_0T(5)n	141	PEx16_0R(13)n	142	PEx16_0R(5)n
39	+5V_SB	40	+5V_SB	91	GND	92	GND	143	GND	144	GND
41	PEx1_2Clkp	42	PEx1_3Clkp	93	PEx16_0T(14)p	94	PEx16_0T(6)p	145	PEx16_0R(14)p	146	PEx16_0R(6)p
43	PEx1_2Clkn	44	PEx1_3Clkn	95	PEx16_0T(14)n	96	PEx16_0T(6)n	147	PEx16_0R(14)n	148	PEx16_0R(6)n
45	DIR	46	PWRGOOD	97	GND	98	GND	149	GND	150	GND
47	SMB_DAT	48	PEx16_Clkp	99	PEx16_0T(15)p	100	PEx16_0T(7)p	151	PEx16_0R(15)p	152	PEx16_0R(7)p
49	SMB_CLK	50	PEx16_Clkn	101	PEx16_0T(15)n	102	PEx16_0T(7)n	153	PEx16_0R(15)n	154	PEx16_0R(7)n
51	SMB_ALERT	52	PSON#	103	GND	104	GND	155	GND	156	GND



SW1: LVDS Resolution select

SW1				DEFINITION
1	2	3	4	
on	on	on	on	800*600/18bit (single)
on	on	on	off	1024*768/18bit (single)
on	on	off	on	1024*768/24bit (single)
on	on	off	off	1280*800/18bit (single)
on	off	on	on	1280*1024/24bit (dual)
on	off	on	off	1366*768/24bit (single)
on	off	off	on	1440*900/24bit (dual)
on	off	off	off	1920*1080/24bit (dual)

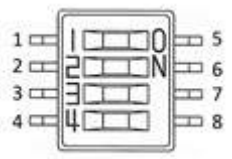

OXY5741A User's Manual

Revision Date: Mar. 10. 2023

SW2: POWER BUTTON

PIN	DEFINITION	
ON	NO LIGHT	
OFF	BLUE LIGHT	

SW3 : CFG5/CFG6

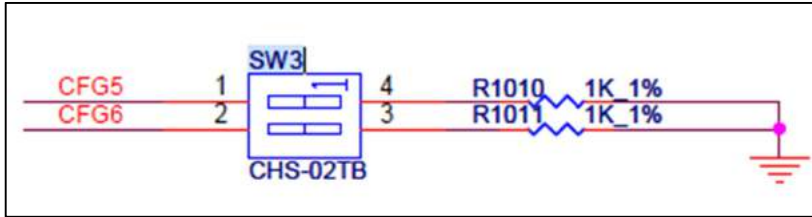

CFG [6:5]:

00=1 x8, 2 x4 PCI Express.

01=Reserved.

10=2 x8 PCI Express.

*11=1 x16 PCI Express.

Chapter 3: AMI BIOS UTILITY

This chapter provides users with detailed descriptions on how to set up a basic system configuration through the AMI BIOS setup utility.

3.1 Starting

To enter the setup screens, perform the following steps:

- Turn on the computer and press the key immediately.
- After the key is pressed, the main BIOS setup menu displays. Other setup screens can be accessed from the main BIOS setup menu, such as the Chipset and Power menus.

3.2 Navigation Keys

The BIOS setup/utility uses a key-based navigation system called hot keys. Most of the BIOS setup utility hot keys can be used at any time during the setup navigation process.

Some of the hot keys are <F1>, <F10>, <Enter>, <ESC>, and <Arrow> keys.



Some of the navigation keys may differ from one screen to another.

Left/Right	The Left and Right <Arrow> keys moves the cursor to select a menu.
Up/Down	The Up and Down <Arrow> keys moves the cursor to select a setup screen or sub-screen.
+– Plus/Minus	The Plus and Minus <Arrow> keys changes the field value of a particular setup setting.
Tab	The <Tab> key selects the setup fields.
F1	The <F1> key displays the General Help screen.
F10	The <F10> key saves any changes made and exits the BIOS setup utility.
Esc	The <Esc> key discards any changes made and exits the BIOS setup utility.
Enter	The <Enter> key displays a sub-screen or changes a selected or highlighted option in each menu.

3.3 Main Menu

The Main menu is the screen that first displays when BIOS Setup is entered, unless an

error has occurred.

When you first enter the BIOS Setup Utility, you will encounter the Main setup screen. You can always return to the Main setup screen by selecting the Main tab. There are two Main Setup options. They are described in this section. The Main BIOS Setup screen is shown below.

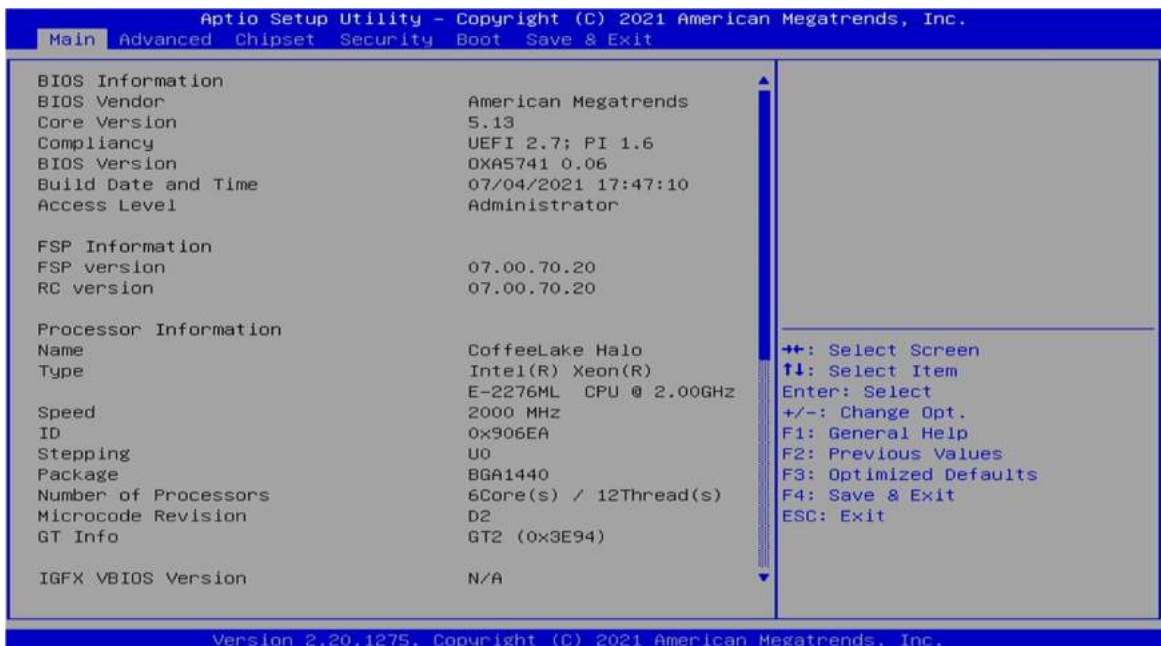

The Main BIOS setup screen has two main frames. The left frame displays all the options that can be configured. Grayed-out options cannot be configured; options in blue can. The right frame displays the key legend. Above the key legend is an area reserved for a text message. When an option is selected in the left frame, it is highlighted in white. Often a text message will accompany it.

● System Date

Use this function to change the system date.

Select System Date using the Up and Down <Arrow> keys. Enter the new values through the keyboard. Press the Left and Right <Arrow> keys to move between fields. The date setting must be entered in MM/DD/YY format.

● System Time

Use this function to change the system time.

Select System Time using the Up and Down <Arrow> keys. Enter the new values through the keyboard. Press the Left and Right <Arrow> keys to move between fields. The time setting is entered in HH:MM:SS format.

Note: The time is in 24-hour format. For example, 5:30 A.M. appears as 05:30:00, and 5:30 P.M. as 17:30:00.

- **Access Level**

Display the access level of the current user in the BIOS.

3.4 Advanced Menu

The Advanced Menu allows you to configure your system for basic operation. Some entries are defaults required by the system board, while others, if enabled, will improve the performance of your system or let you set some features according to your preference.

Setting incorrect field values may cause the system to malfunction.

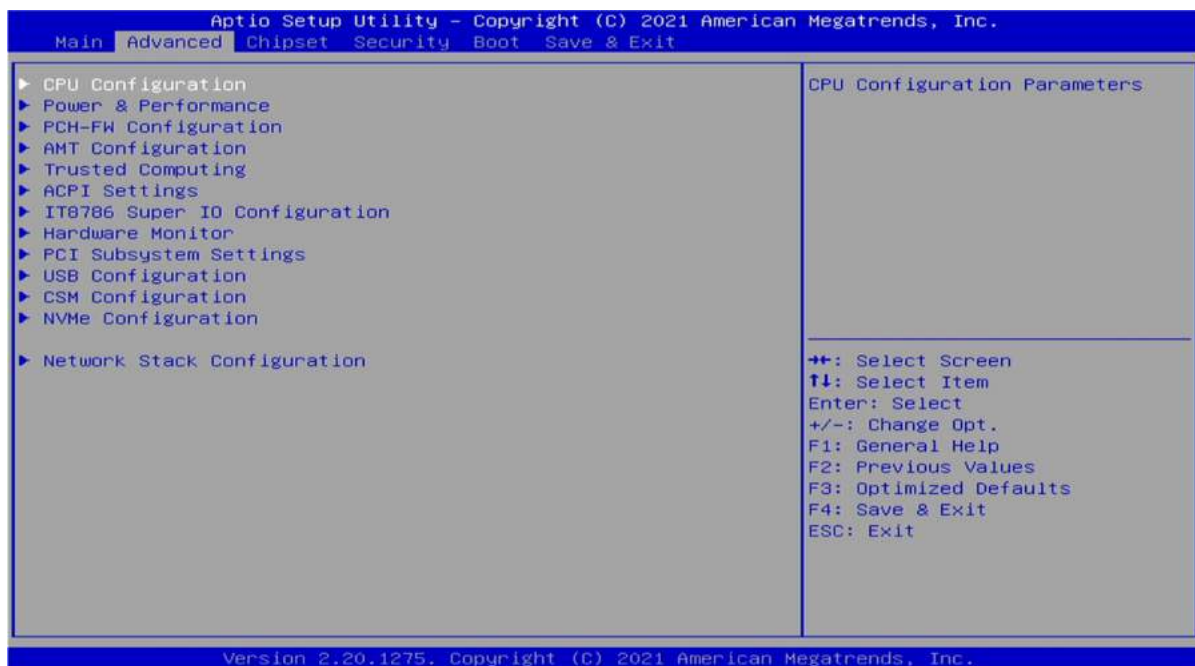

3.4.1 CPU Configuration

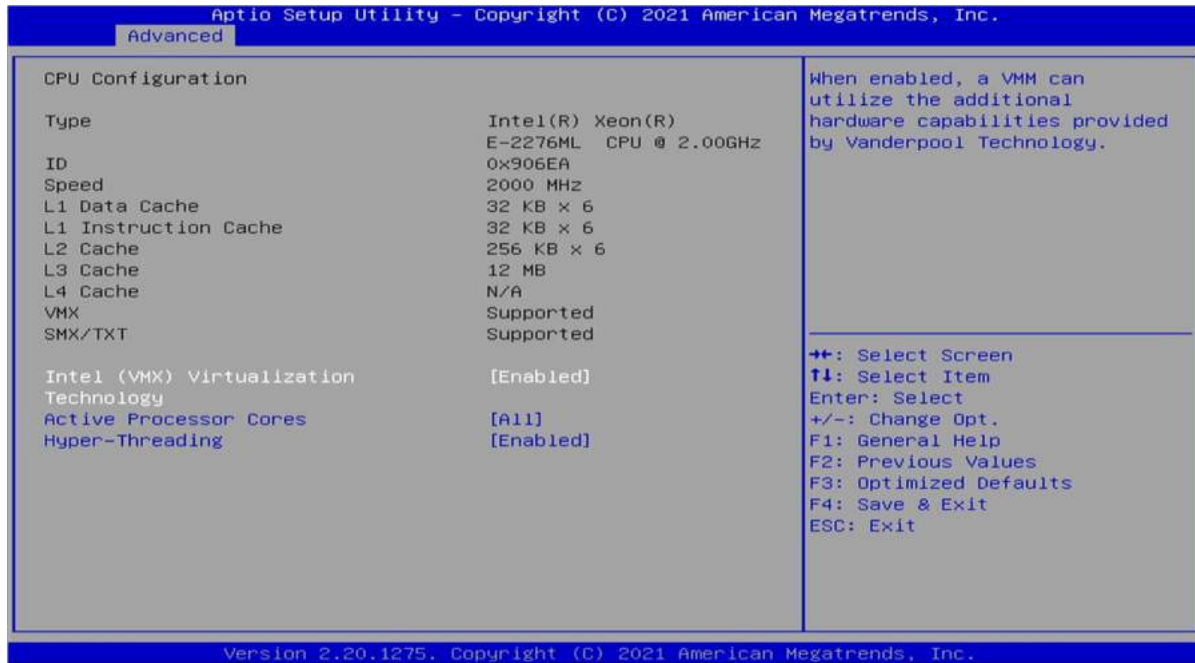

Field Name	Intel (VMX) Virtualization Technology
Default Value	[Enabled]
Possible Value	Disabled Enabled

Field Name	Active Processor Cores
Default Value	[A11]
Possible Value	A11 1 2 3 4 5

Field Name	Hyper-Threading
Default Value	[Enabled]
Possible Value	Disabled Enabled

OXY5741A User's Manual

Revision Date: Mar. 10. 2023

3.4.2 Power & Performance

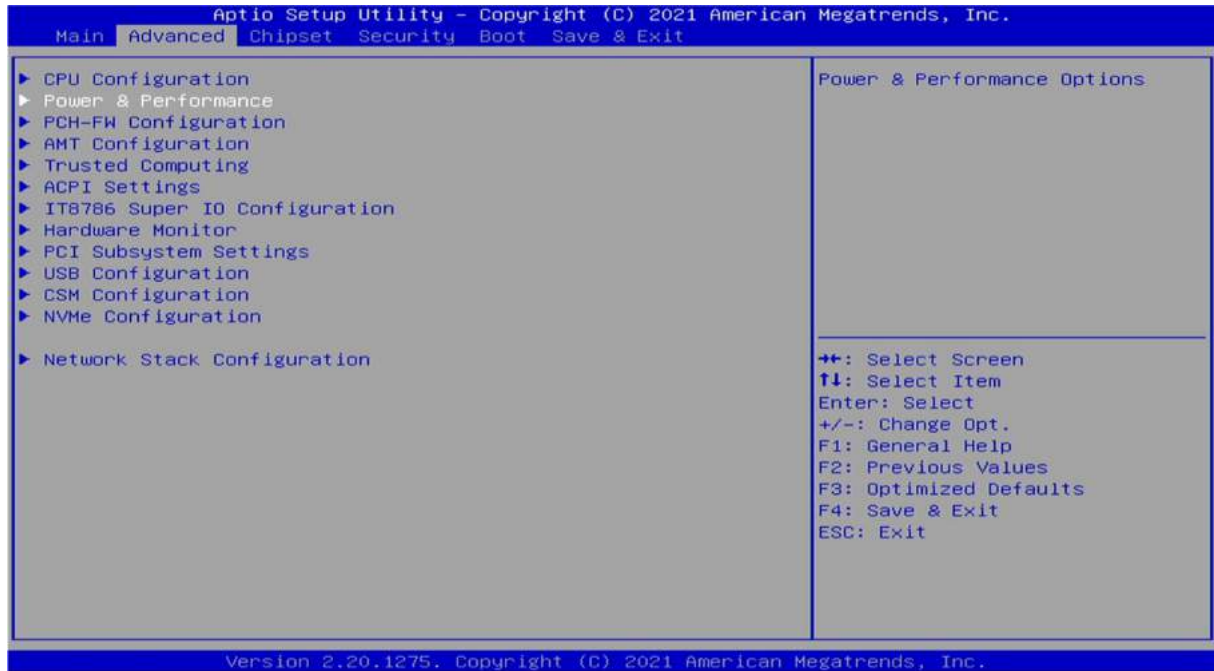

Field Name	Intel (R) SpeedStep(tm)
Default Value	[Enabled]
Possible Value	Disabled Enabled

Field Name	Turbo Mode
Default Value	[Enabled]
Possible Value	Disabled Enabled

Field Name	C states
Default Value	[Disabled]
Possible Value	Disabled Enabled

OXY5741A User's Manual

Revision Date: Mar. 10. 2023



Field Name	ME State
Default Value	[Enabled]
Possible Value	Disabled Enabled

Field Name	Manageability Features State
Default Value	[Enabled]
Possible Value	Disabled Enabled

Field Name	AMT BIOS Features
Default Value	[Enabled]
Possible Value	Disabled Enabled

3.4.4 AMT Configuration

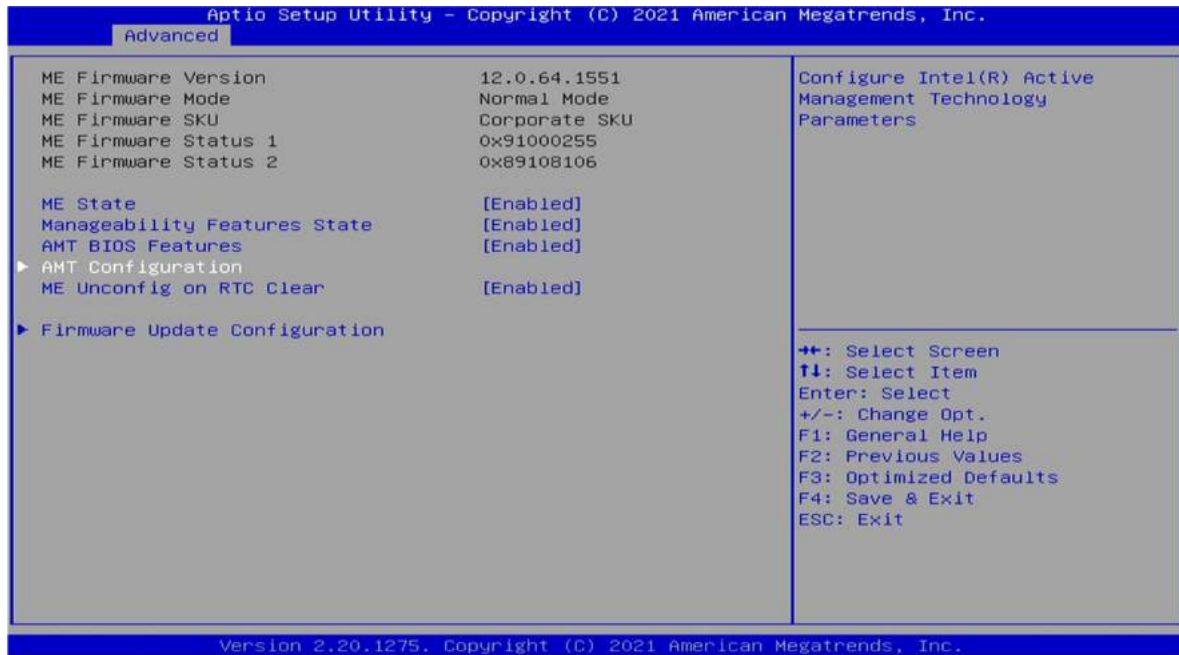

Field Name	ASF support
Default Value	[Enabled]
Possible Value	Disabled Enabled

Field Name	USB Provisioning of AMT
Default Value	[Disabled]
Possible Value	Disabled Enabled

3.4.4.1 CIRA Configuration

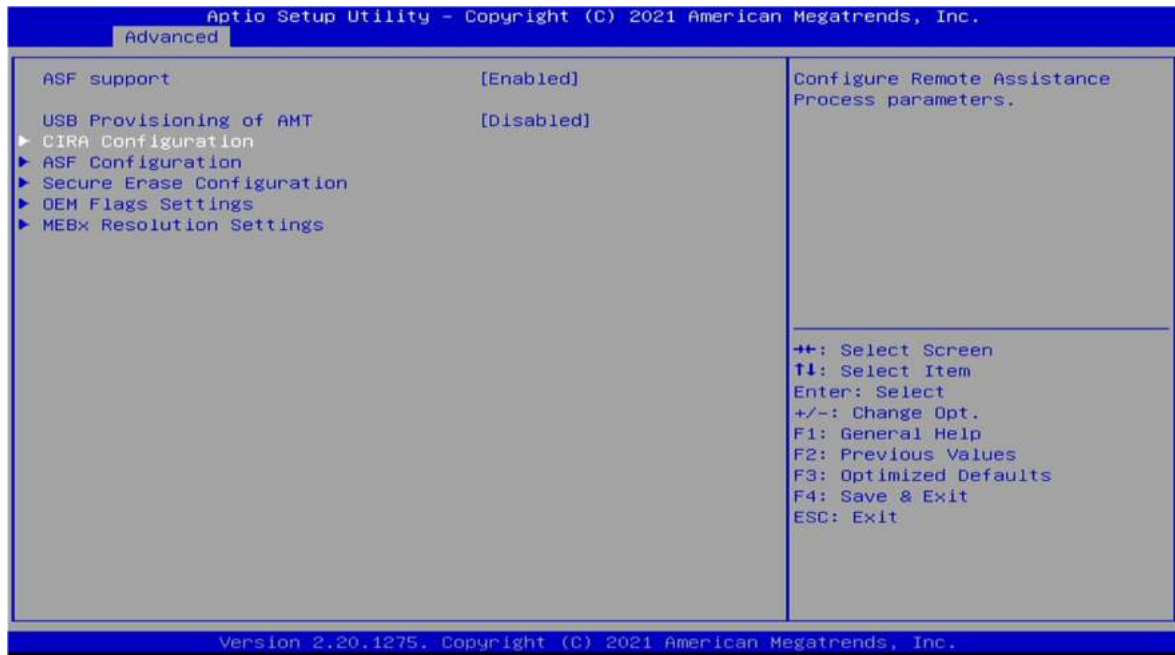

Field Name	Activate Remote Assistance Process
Default Value	[Disabled]
Possible Value	Disabled Enabled

3.4.4.2 ASF Configuration

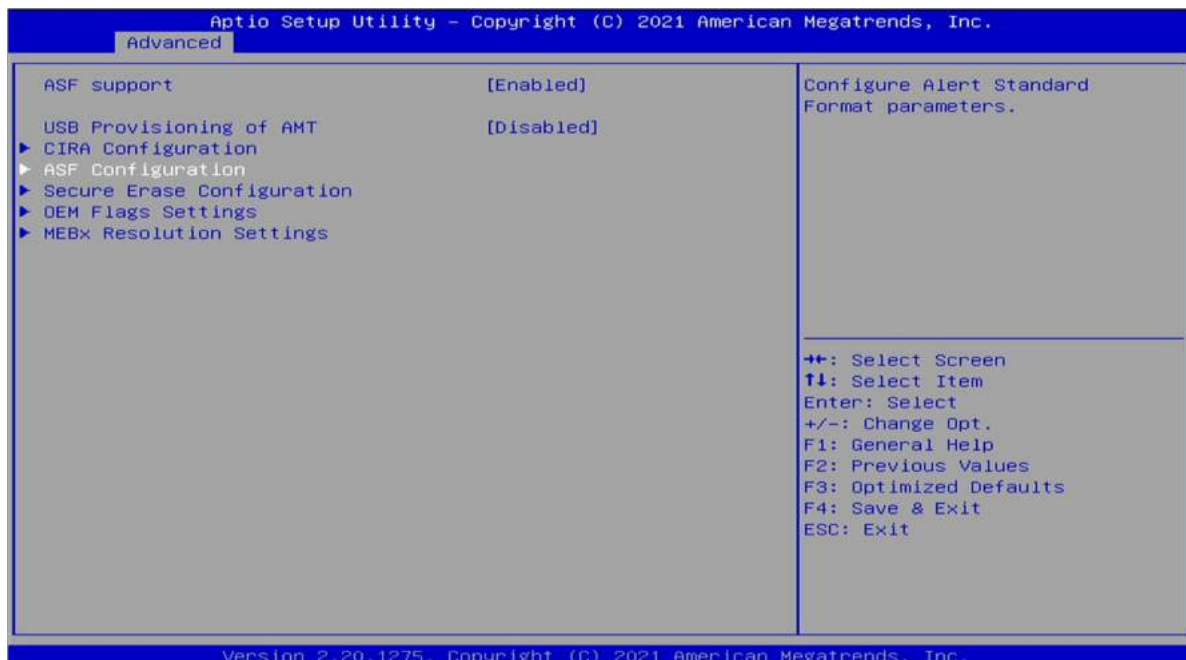

Field Name	PET Progress
-------------------	---------------------

OXY5741A User's Manual

Revision Date: Mar. 10. 2023

Default Value	[Enabled]
Possible Value	Disabled Enabled

Field Name	WatchDog
Default Value	[Disabled]
Possible Value	Disabled Enabled

Field Name	ASF Sensors Table
Default Value	[Disabled]
Possible Value	Disabled Enabled

3.4.4.3 Secure Erase Configuration



Field Name	Secure Erase mode
Default Value	[Simulated]
Possible Value	Simulated Real

Field Name	Force Secure Erase
-------------------	---------------------------

OXY5741A User's Manual

Revision Date: Mar. 10. 2023

Default Value	[Disabled]
Possible Value	Disabled Enabled

3.4.4.4 OEM Flags Settings

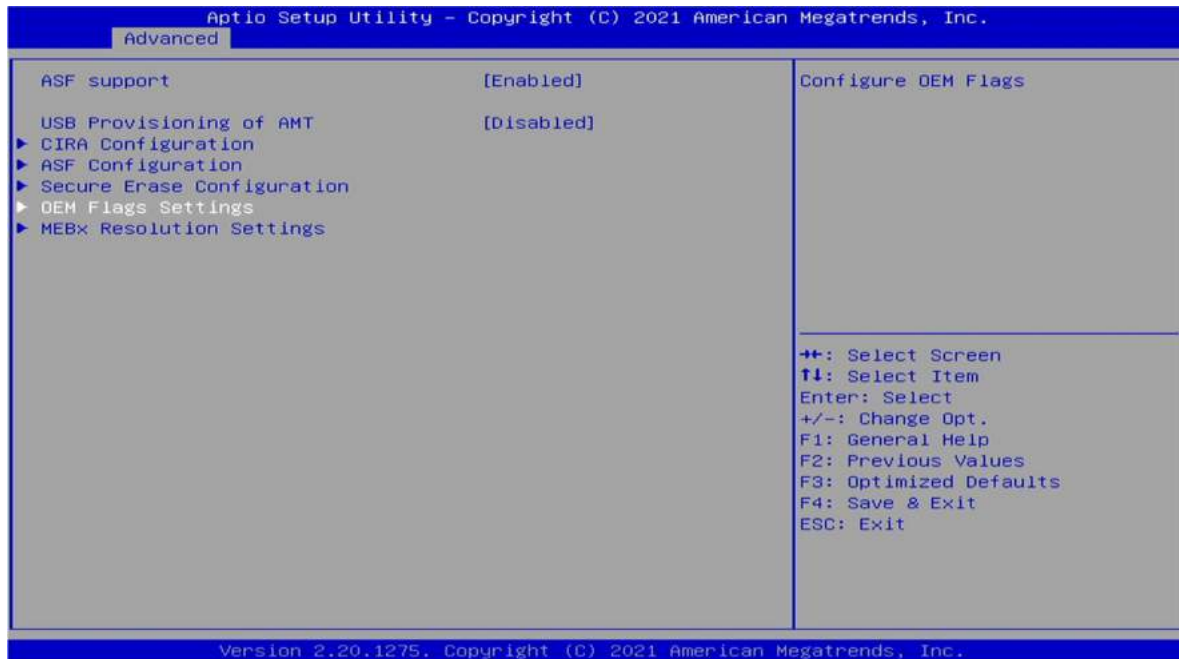

Field Name	MEBx hotkey Pressed
Default Value	[Disabled]
Possible Value	Disabled Enabled

Field Name	MEBx Selection Screen
Default Value	[Disabled]
Possible Value	Disabled Enabled

Field Name	Hide Unconfigure ME Confirmation Prompt
Default Value	[Disabled]
Possible Value	Disabled Enabled

Field Name	MEBx OEM Debug Menu Enable
-------------------	-----------------------------------

OXY5741A User's Manual

Revision Date: Mar. 10. 2023

Default Value	[Disabled]
Possible Value	Disabled Enabled

Field Name	Unconfigure ME
Default Value	[Disabled]
Possible Value	Disabled Enabled

3.4.4.5 MEBx Resolution Settings

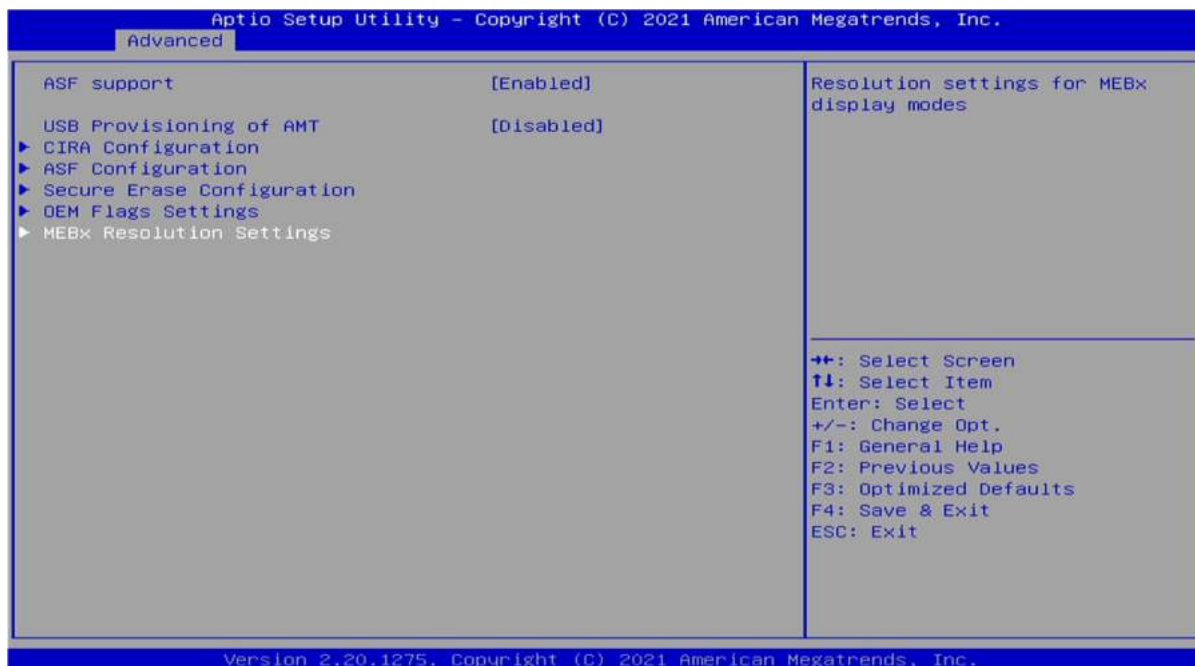

Field Name	Non-UI Mode Resoultion
Default Value	[Auto]
Possible Value	Auto 80x25 100x31

Field Name	UI Mode Resolution
Default Value	[Auto]
Possible Value	Auto 80x25 100x31
Field Name	Graphics Mode Resoultion

OXY5741A User's Manual

Revision Date: Mar. 10. 2023

Default Value	[Auto]
Possible Value	Auto 640x480 800x600 1024x768

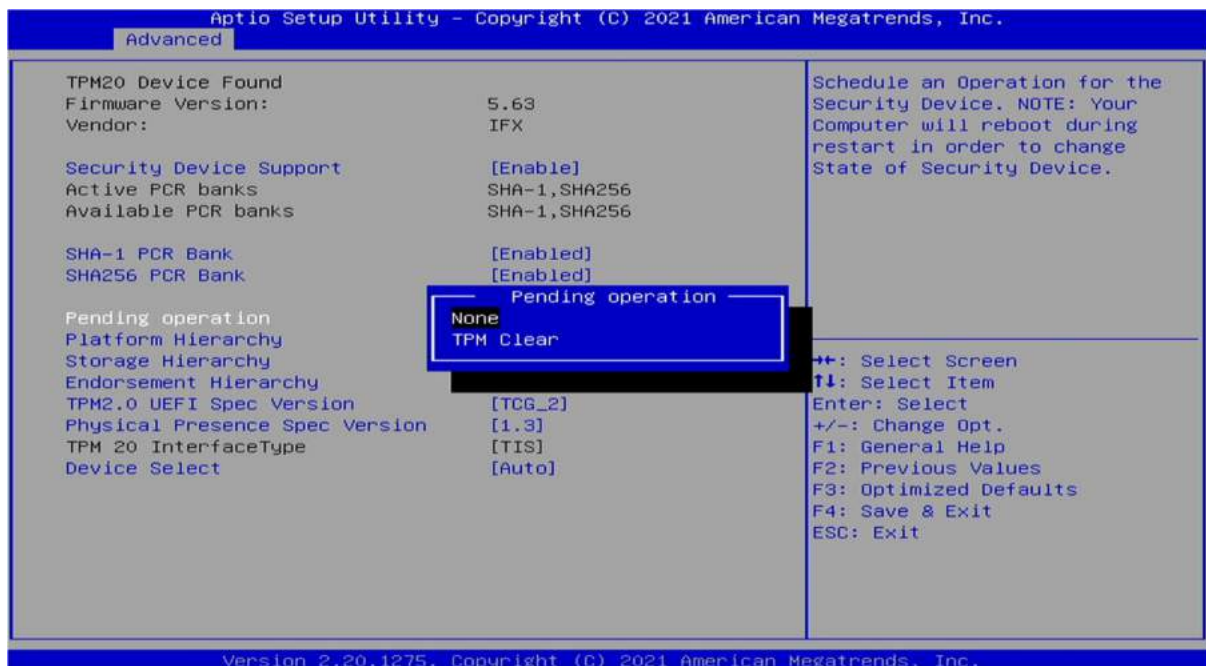

Field Name	Pending operation
Default Value	[None]
Possible Value	None TPM Clear

OXY5741A User's Manual

Revision Date: Mar. 10. 2023

3.4.5 Trusted Computing

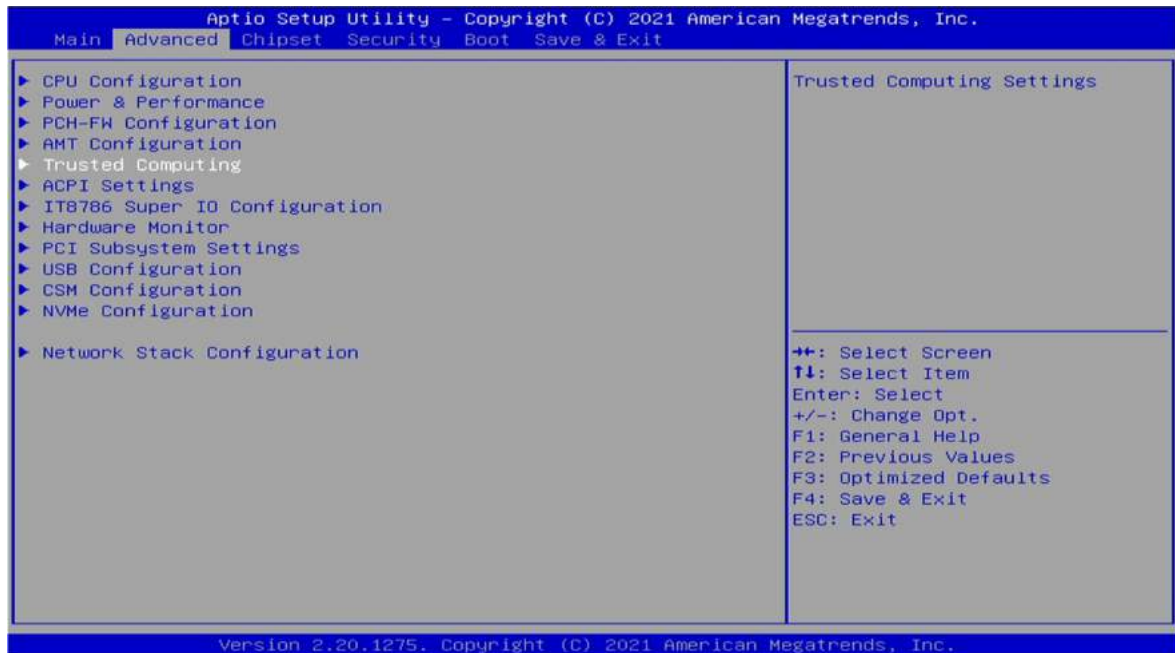

Field Name	Security Device Support
Default Value	[Enabled]
Possible Value	Disabled Enabled

Field Name	SHA-1 PCR Bank
Default Value	[Enabled]
Possible Value	Disabled Enabled

Field Name	SHA256 PCR Bank
Default Value	[Enabled]
Possible Value	Disabled Enabled

Field Name	Pending operation
Default Value	[None]
Possible Value	None TPM Clear

Field Name	Platform Hierarchy
-------------------	---------------------------

OXY5741A User's Manual

Revision Date: Mar. 10. 2023

Default Value	[Enabled]
Possible Value	Disabled Enabled

Field Name	Storage Hierarchy
Default Value	[Enabled]
Possible Value	Disabled Enabled

Field Name	Endorsement Hierarchy
Default Value	[Enabled]
Possible Value	Disabled Enabled

Field Name	TPM2.0 UEFI Spec Version
Default Value	[TCG_2]
Possible Value	TCG_1_2 TCG_2

Field Name	Physical Presence Spec Version
Default Value	[1.3]
Possible Value	1.2 1.3

Field Name	Device Select
Default Value	[Auto]
Possible Value	TPM 1.2 TPM 2.0 Auto

OXY5741A User's Manual

Revision Date: Mar. 10. 2023

3.4.6 ACPI Settings

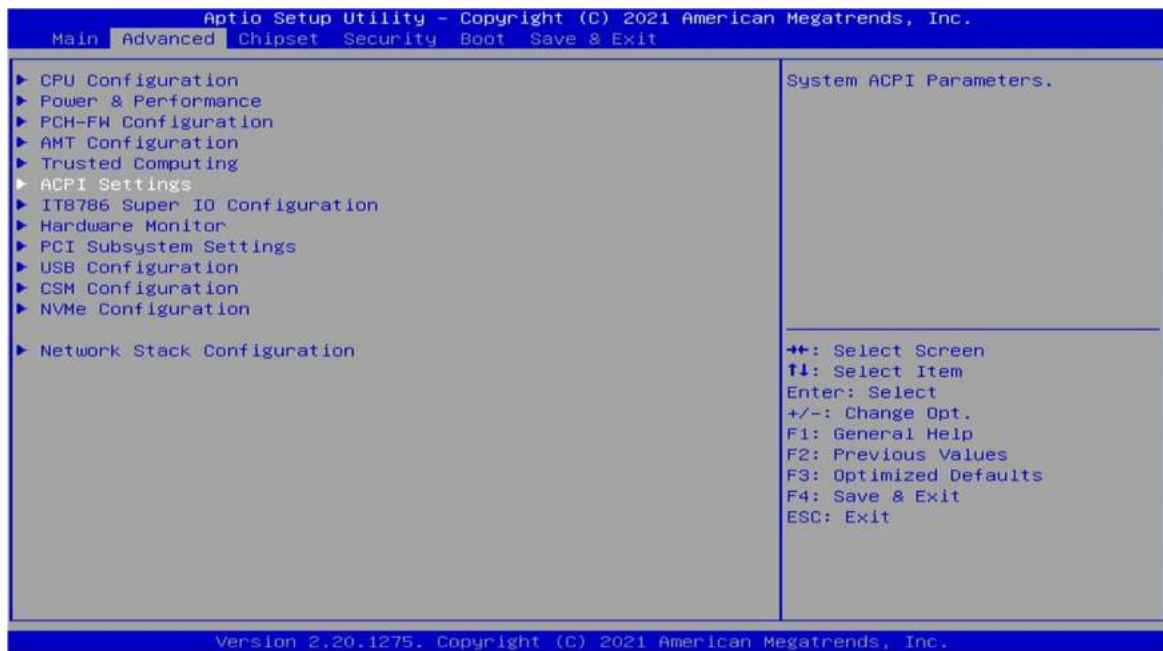

Field Name	Enable ACPI Auto Configuration
Default Value	[Disabled]
Possible Value	Disabled Enabled

Field Name	Enable Hibernation
Default Value	[Enabled]
Possible Value	Disabled Enabled

Field Name	ACPI Sleep State
Default Value	[S3 (Suspend to RAM)]
Possible Value	Suspend Disabled S3 (Suspend to RAM)

Field Name	Lock Legacy Resources
Default Value	[Disabled]
Possible Value	Disabled Enabled

3.4.7 IT8786 Super IO Configuration

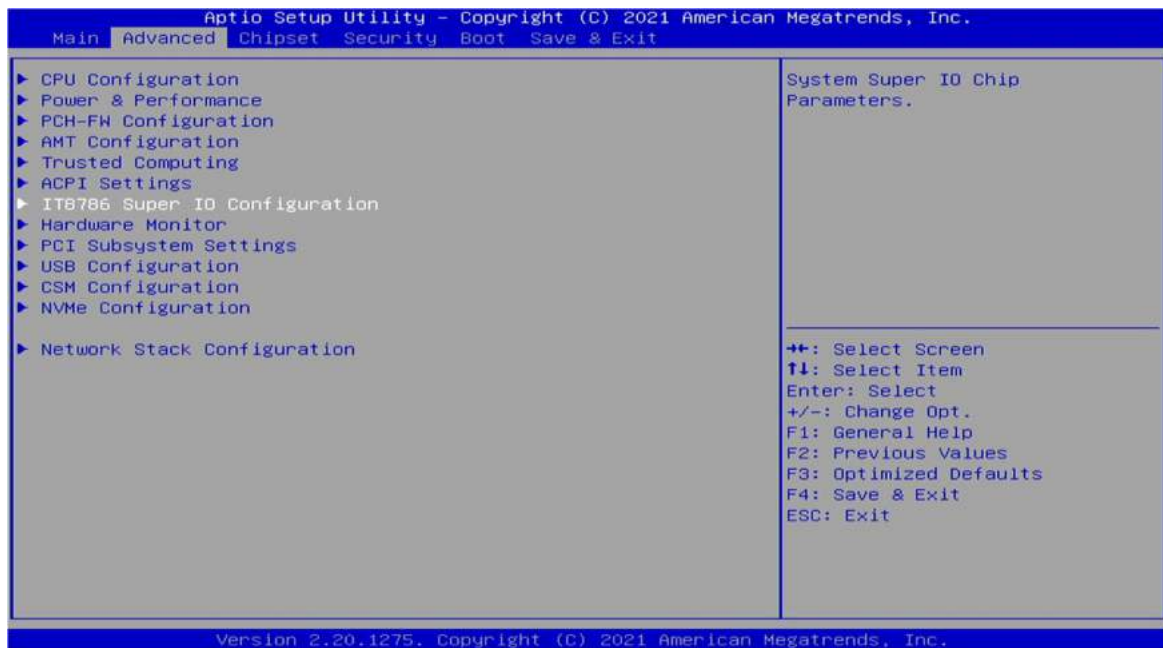

3.4.7.1 Social Port 1 Configuration

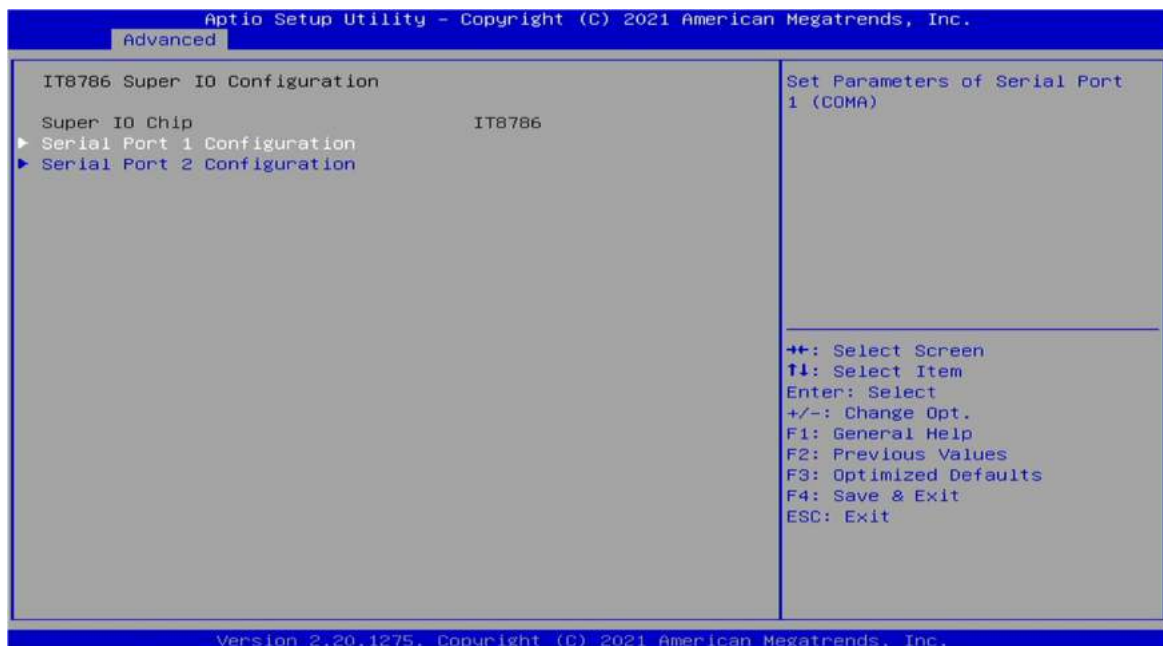

Field Name	Serial Port
Default Value	[Enabled]
Possible Value	Disabled Enabled

OXY5741A User's Manual

Revision Date: Mar. 10. 2023

Field Name	COM1 Control
Default Value	[RS-232]
Possible Value	Loopback RS-232 RS-485 Half Duplex RS-485/422 Full Duplex

3.4.7.2 Serial Port 2 Configuration



Field Name	Serial Port
Default Value	[Enabled]
Possible Value	Disabled Enabled

Field Name	COM2 Control
Default Value	[RS-232]
Possible Value	Loopback RS-232 RS-485 Half Duplex RS-485/422 Full Duplex

OXY5741A User's Manual

Revision Date: Mar. 10. 2023

3.4.8 Hardware Monitor

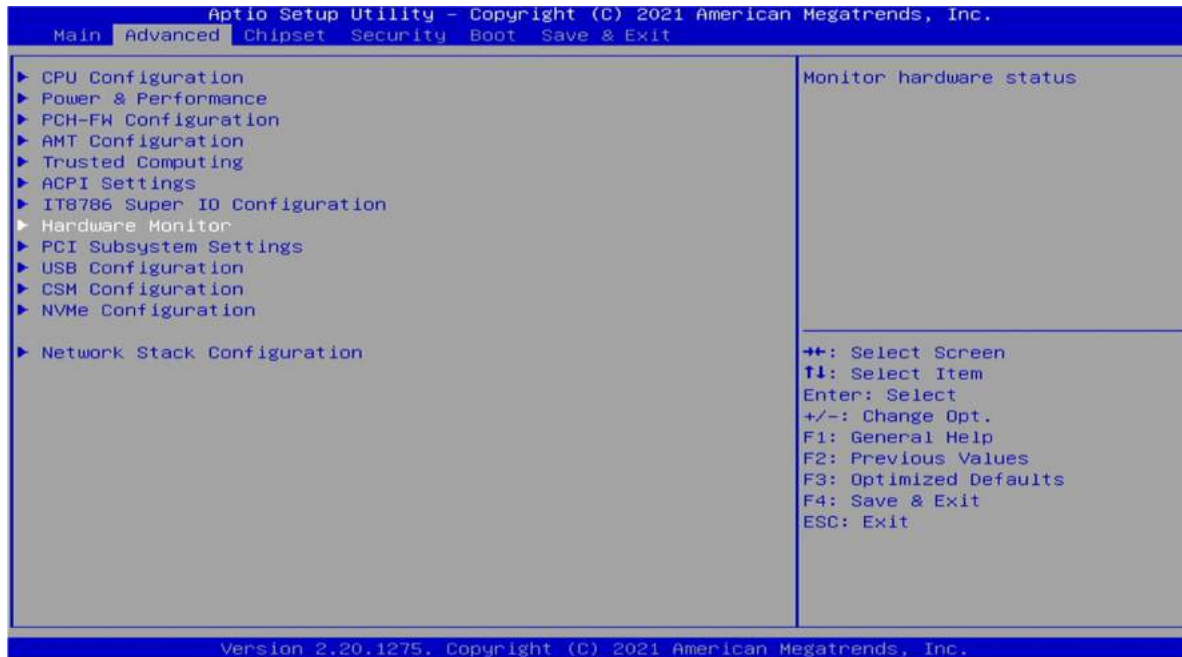

3.4.8.1 Smart Fan Function



Field Name	FAN_CTL Polarity
Default Value	[Active high]
Possible Value	Active low Active high

Field Name	Smoothing control
------------	-------------------

OXY5741A User's Manual

Revision Date: Mar. 10. 2023

Default Value	[4Hz]
Possible Value	1Hz 16Hz 8Hz 4Hz

3.4.8.2 System Fan Setting



Field Name	Smart Fan Mode
Default Value	[Automatic Mode]
Possible Value	Software Mode Automatic Mode

Field Name	Smart Fan Mode
Default Value	[Automatic Mode]
Possible Value	Software Mode Automatic Mode

Field Name	System Fan Type
Default Value	[PWM]
Possible Value	PWM RPM
Field Name	Temperature select

OXY5741A User's Manual

Revision Date: Mar. 10. 2023

Default Value	[TMP IN3]
Possible Value	TMP IN1 TMP IN2 TMP IN3

3.4.9 PCI Subsystem Settings

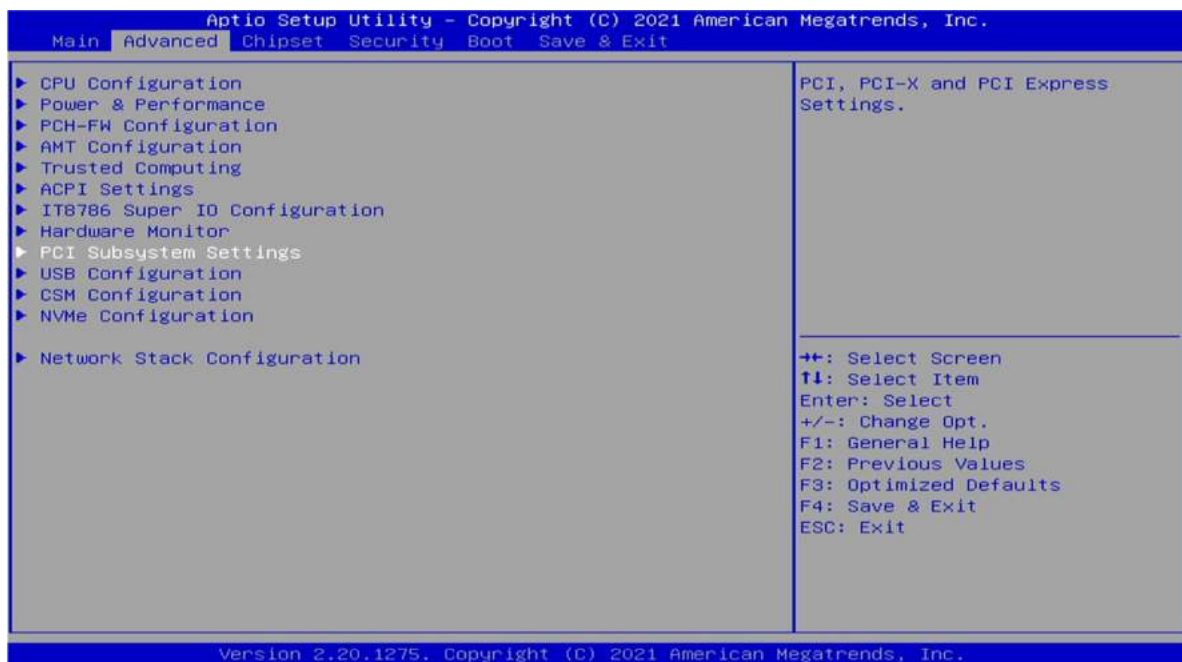

Field Name	Above 4G Decoding
Default Value	[Disabled]
Possible Value	Disabled Enabled

OXY5741A User's Manual

Revision Date: Mar. 10. 2023

3.4.10 USB Configuration

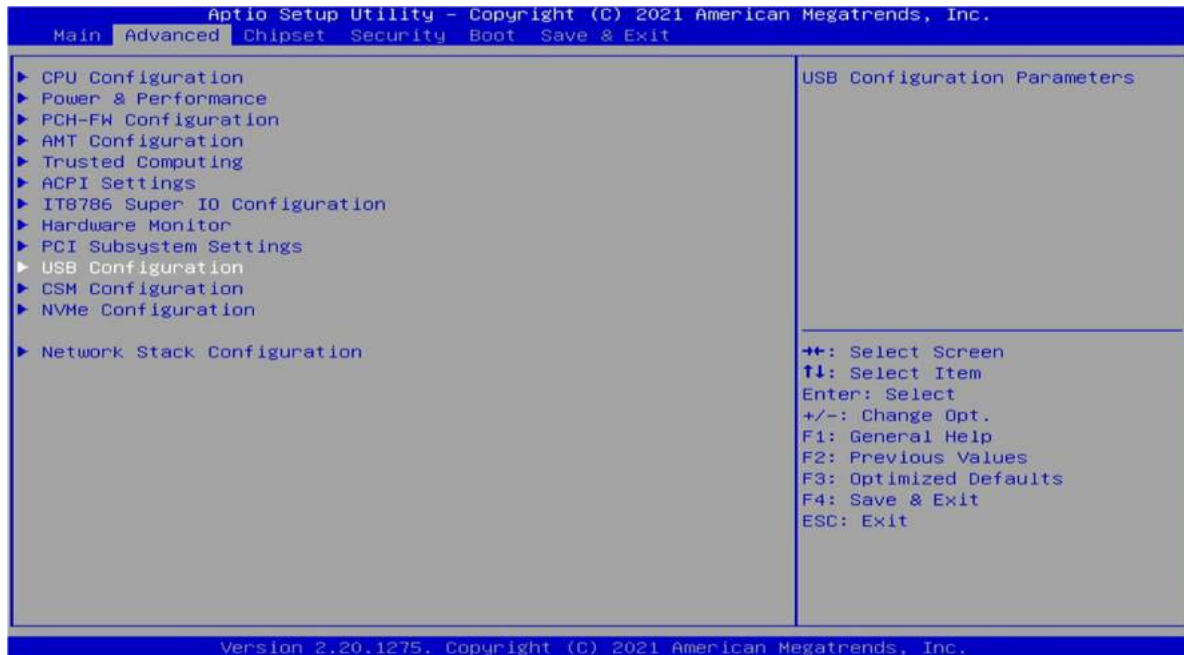

Field Name	Legacy USB Support
Default Value	[Enabled]
Possible Value	Enabled Disabled Auto

Field Name	XHCI Hand-off
Default Value	[Enabled]
Possible Value	Enabled Disabled

Field Name	USB Mass Storage Driver Support
Default Value	[Enabled]
Possible Value	Disabled Enabled

Field Name	USB transfer time-out
-------------------	------------------------------

OXY5741A User's Manual

Revision Date: Mar. 10. 2023

Default Value	[20 sec]
Possible Value	1 sec 5 sec 10 sec 20 sec

Field Name	Device reset time-out
Default Value	[20 sec]
Possible Value	10 sec 20 sec 30 sec 40 sec

Field Name	Device power-up delay
Default Value	[Auto]
Possible Value	Auto Manual

3.4.11 CSM Configuration

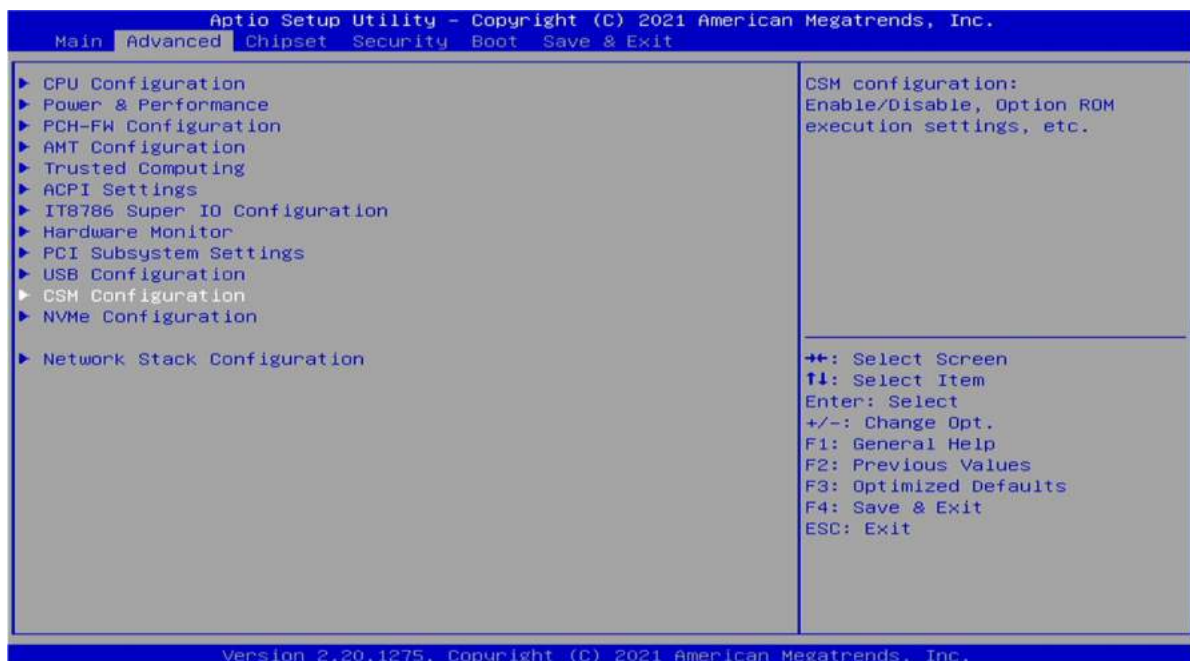

Field Name	CSM Support
-------------------	--------------------

OXY5741A User's Manual

Revision Date: Mar. 10. 2023

Default Value	[Disabled]
Possible Value	Disabled Enabled

3.4.12 NVMe Configuration

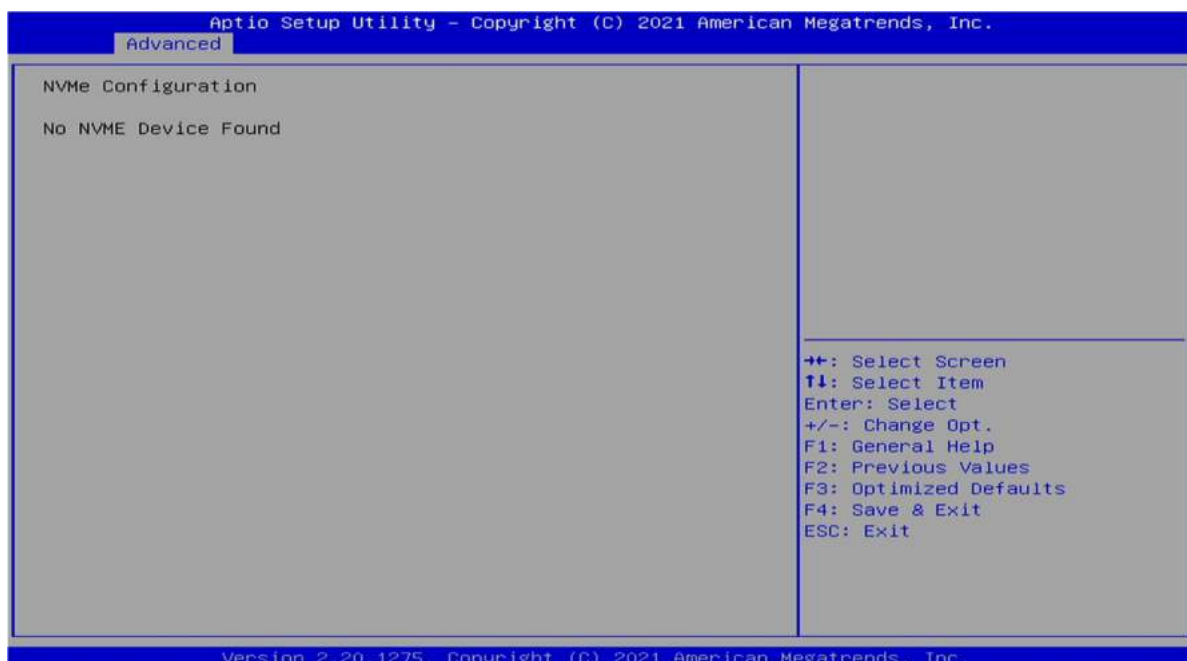
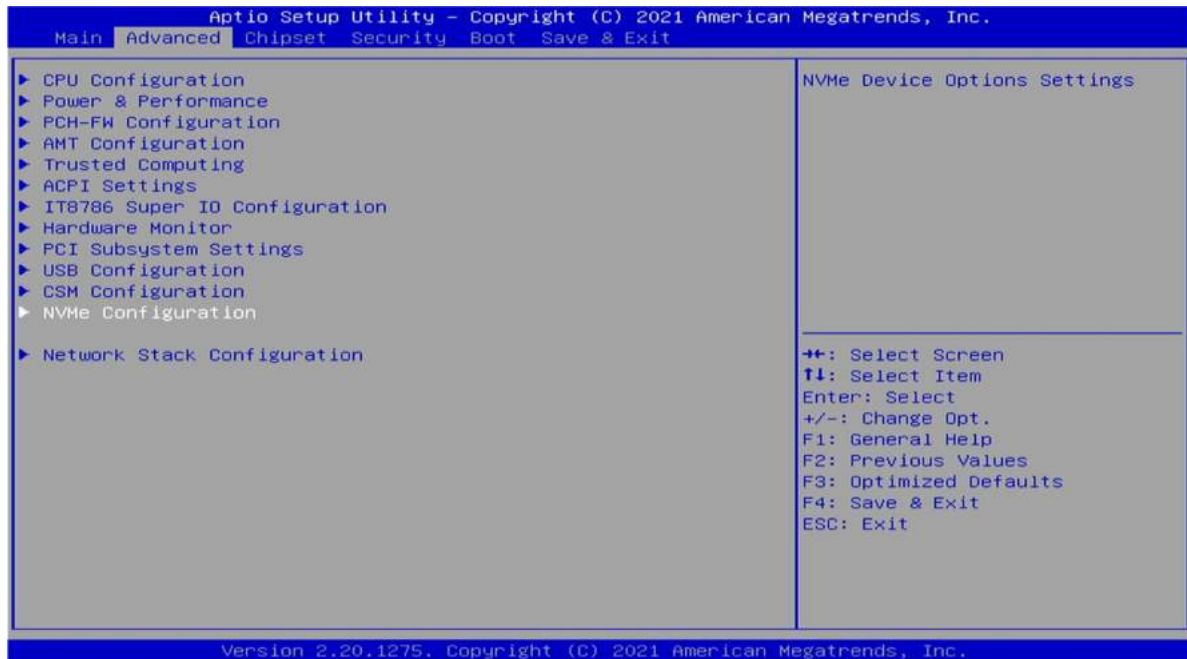

3.4.13 Network Stack Configuration

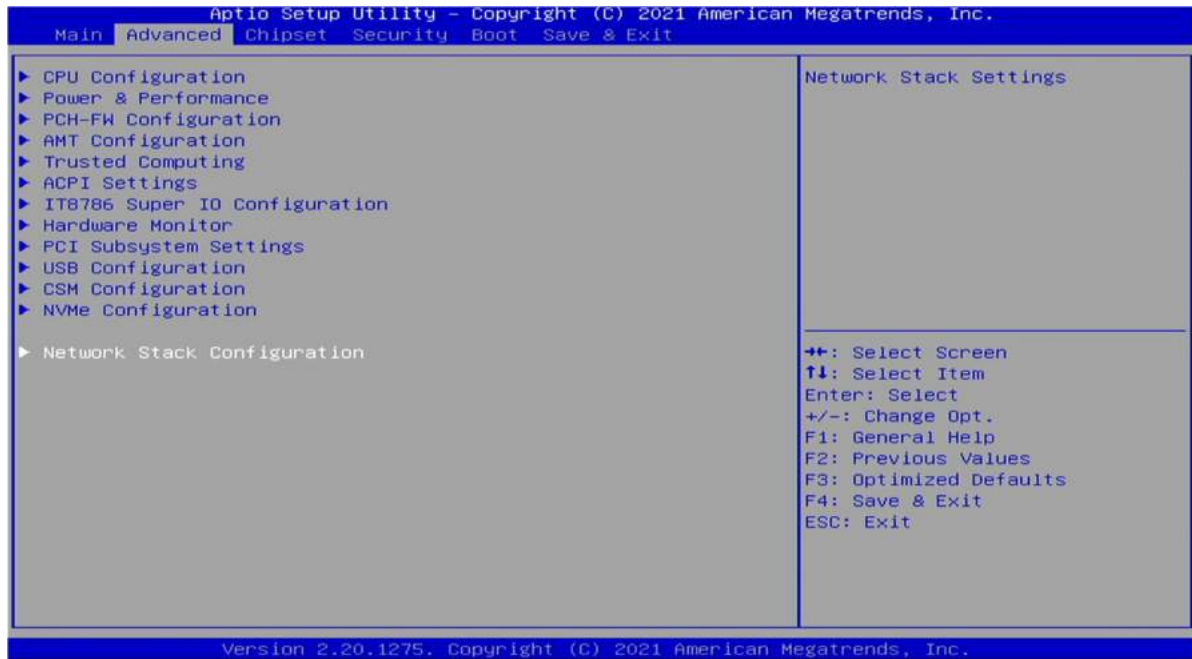

Field Name	Network Stack
Default Value	[Disabled]
Possible Value	Disabled Enabled

3.5.1 System Agent (SA) Configuration

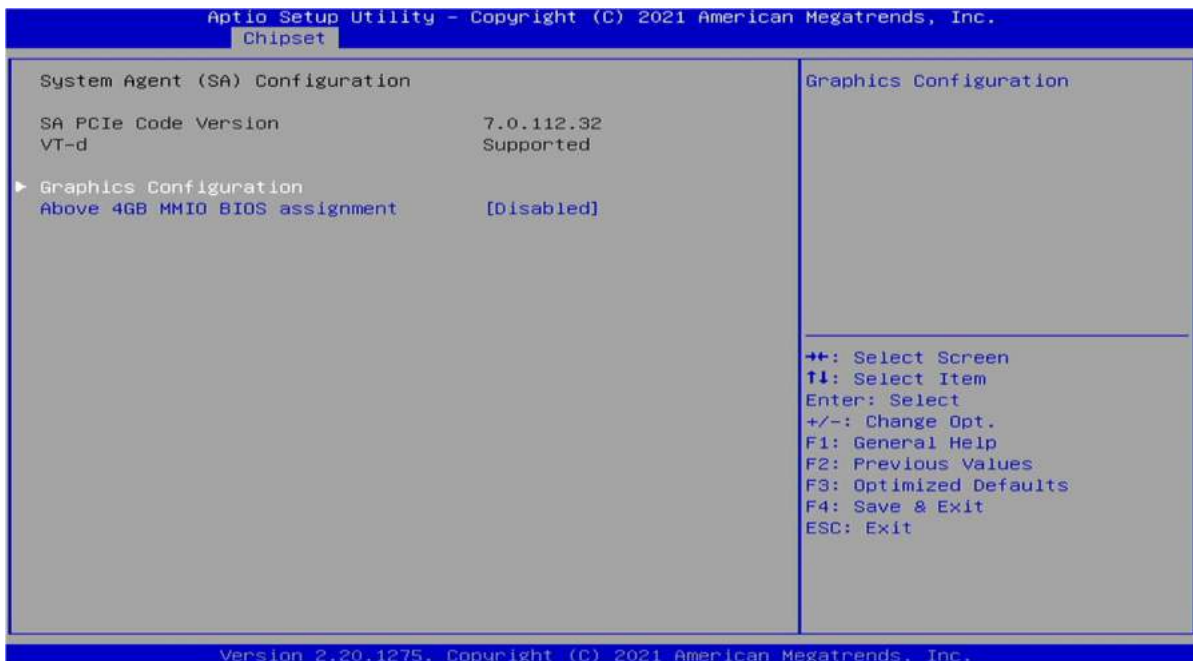
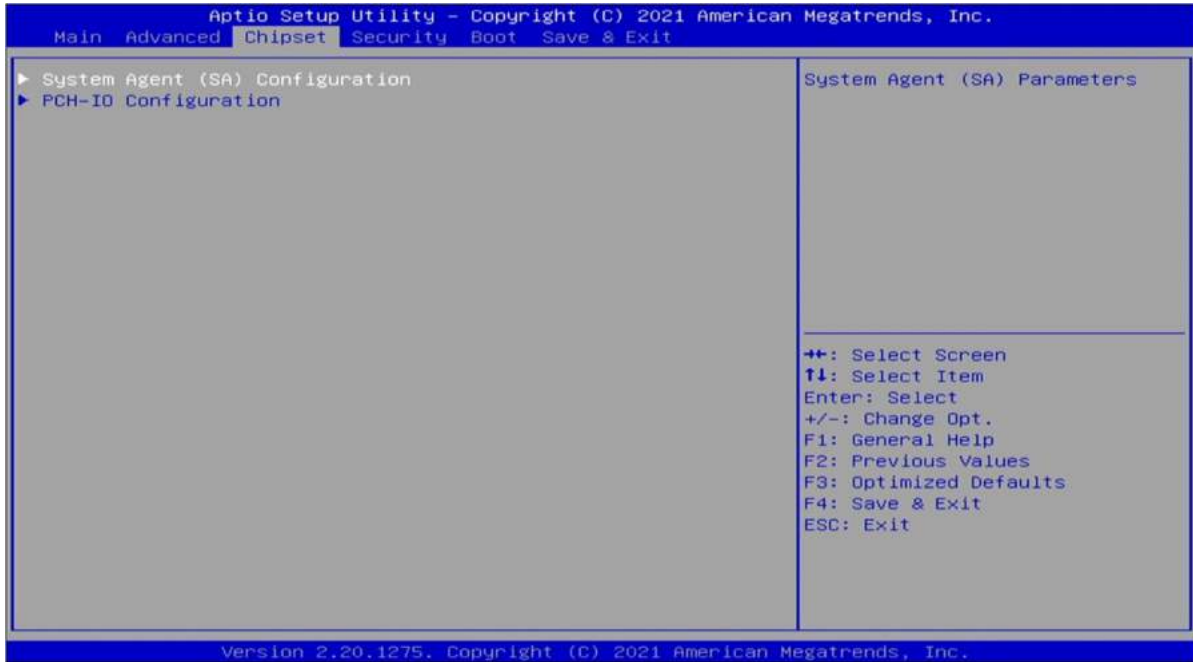

OXY5741A User's Manual

Revision Date: Mar. 10. 2023

Field Name	Primary Display
Default Value	[Auto]
Possible Value	Auto IGFX PEG PCI SG

Field Name	Internal Graphics
Default Value	[Auto]
Possible Value	Auto Disabled Enabled

Field Name	GTT Size
Default Value	[8MB]
Possible Value	2MB 4MB 8MB

Field Name	Aperture Size
Default Value	[256MB]
Possible Value	128MB 256MB 512MB 1024MB 2048MB

Field Name	DVMT Pre-Allocated
-------------------	---------------------------

OXY5741A User's Manual

Revision Date: Mar. 10. 2023

Default Value	[32M]
Possible Value	0M 32M 64M 4M 8M 12M 16M 20M 24M 28M 32M/F7 36M 40M 44M 48M 52M 56M 60M

Field Name	DVMT Total Gfx Mem
Default Value	[128M]
Possible Value	128M 256M MAX

Field Name	Above 4GB MMIO BIOS assignment
Default Value	[Enabled]
Possible Value	Enabled Disabled

OXY5741A User's Manual

Revision Date: Mar. 10. 2023

3.5.2 PCH-IO Configuration

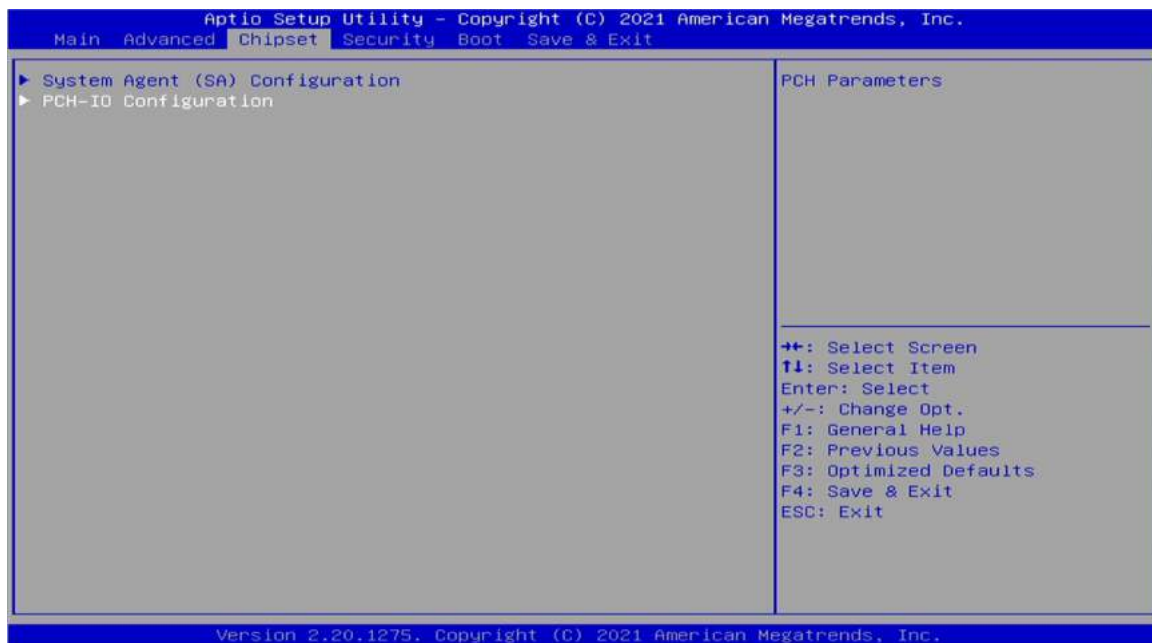

3.5.2.1 PCI Express Configuration



Field Name	PCIe function swap
Default Value	[Disabled]
Possible Value	Disabled Enabled

OXY5741A User's Manual

Revision Date: Mar. 10. 2023

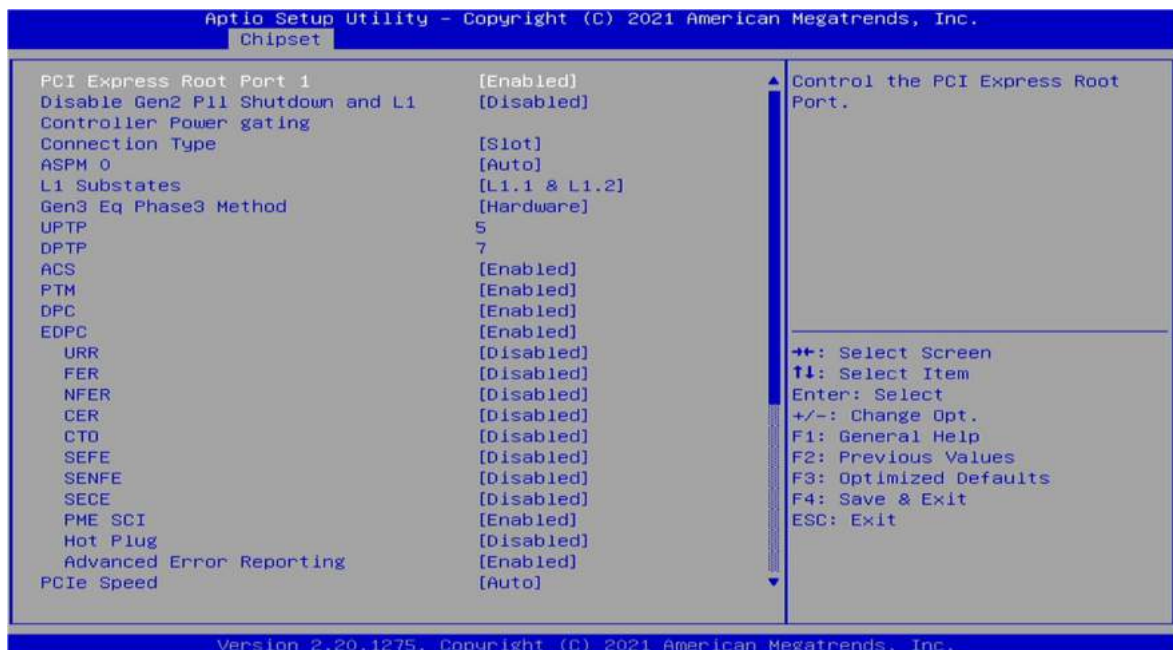
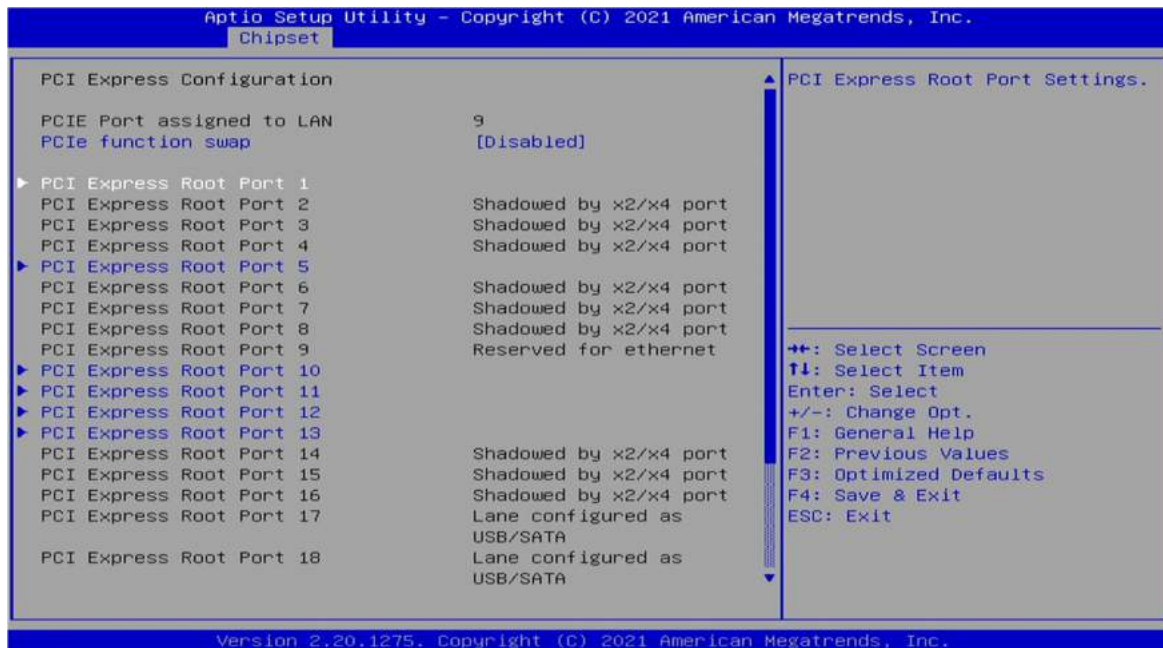

Field Name	PCI Express Root Port 1
Default Value	[Enabled]

Field Name	PCI Express Root Port 5
Default Value	[Enabled]

Field Name	PCI Express Root Port 10
Default Value	[Enabled]
Field Name	PCI Express Root Port 11

OXY5741A User's Manual

Revision Date: Mar. 10. 2023

Default Value	[Enabled]
---------------	-----------

Field Name	PCI Express Root Port 12
Default Value	[Enabled]

Field Name	PCI Express Root Port 13
Default Value	[Enabled]

3.5.2.2 SATA And RST Configuration

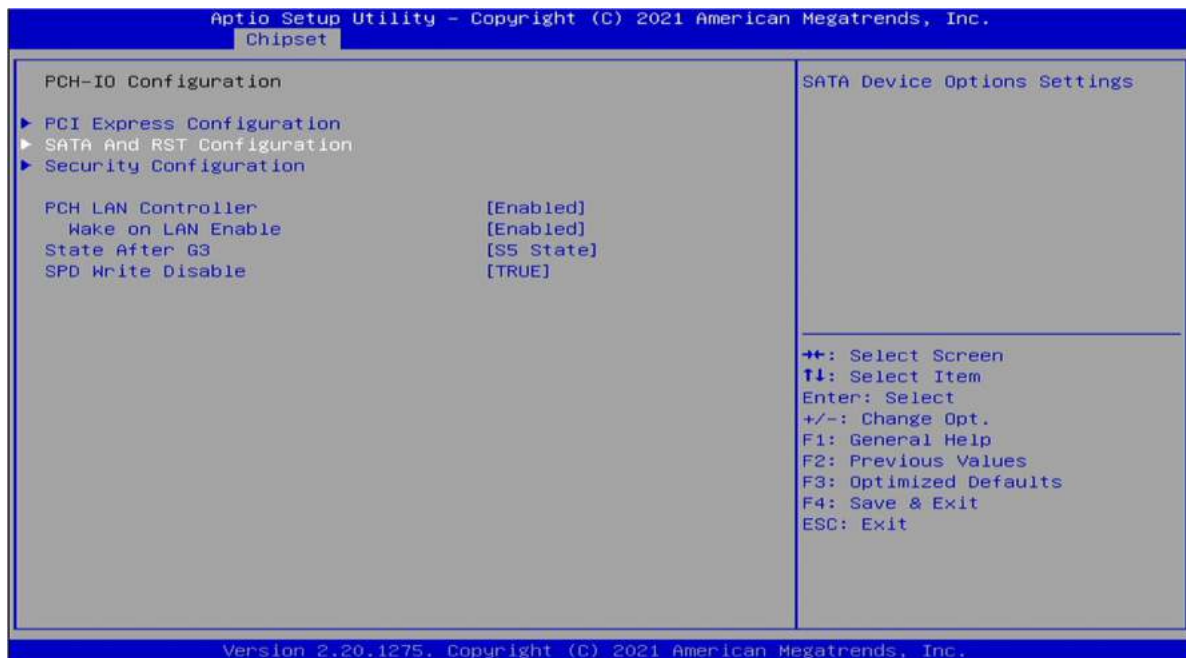

Field Name	SATA Controller(s)
Default Value	[Enabled]
Possible Value	Enabled Disabled

Field Name	SATA Mode Selection
Default Value	[AHCI]
Possible Value	AHCI Intel RST Premium With Intel Optane System Acceleration

Field Name	M.2 Port
-------------------	-----------------

OXY5741A User's Manual

Revision Date: Mar. 10. 2023

Default Value	[Disabled]
Possible Value	Disabled Enabled

Field Name	Port 1
Default Value	[Enabled]
Possible Value	Disabled Enabled

Field Name	Port 2
Default Value	[Enabled]
Possible Value	Disabled Enabled

Field Name	Port 3
Default Value	[Enabled]
Possible Value	Disabled Enabled

Field Name	Port 4
Default Value	[Enabled]
Possible Value	Disabled Enabled

OXY5741A User's Manual

Revision Date: Mar. 10. 2023

3.5.2.3 Security Configuration

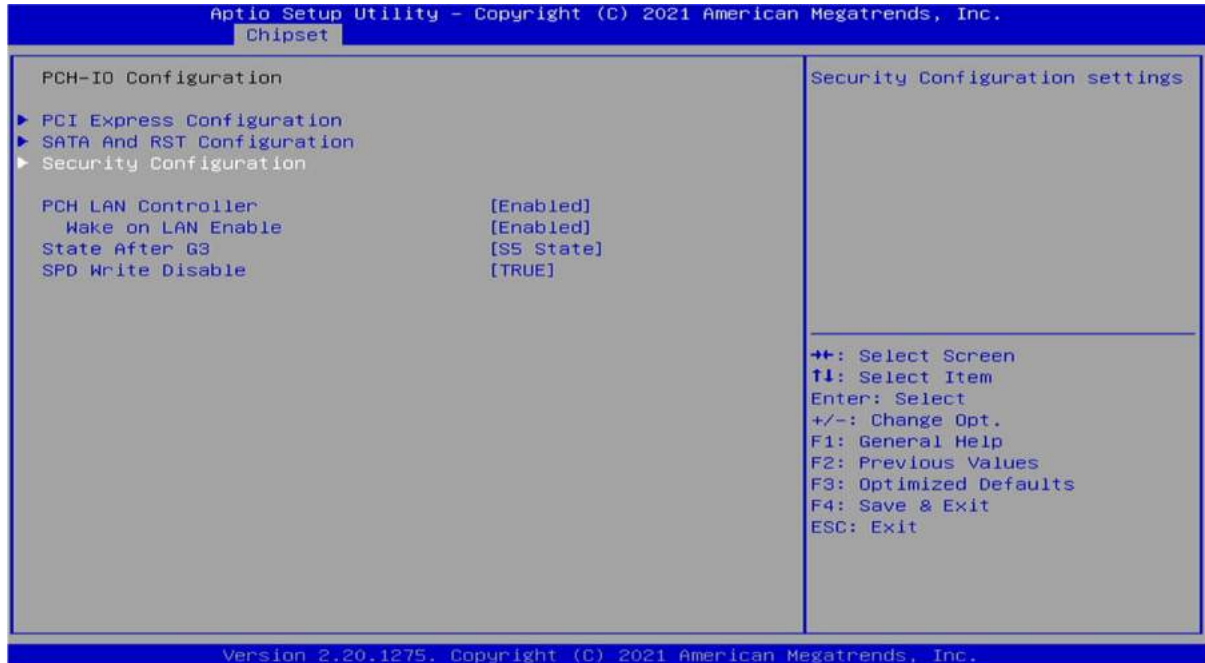

Field Name	RTC Memory Lock
Default Value	[Enabled]
Possible Value	Disabled Enabled

Field Name	BIOS Lock
Default Value	[Enabled]
Possible Value	Disabled Enabled

Field Name	Force unlock on all GPIO pads
Default Value	[Disabled]
Possible Value	Disabled Enabled

Field Name	PCH LAN Controller
Default Value	[Enabled]
Possible Value	Enabled Disabled

Field Name	Wake on LAN Enable
-------------------	---------------------------

OXY5741A User's Manual

Revision Date: Mar. 10. 2023

Default Value	[Enabled]
Possible Value	Enabled Disabled

Field Name	State After G3
Default Value	[S5 State]
Possible Value	S0 State S5 State

Field Name	SPD Write Disable
Default Value	[TRUE]
Possible Value	TRUE FALSE

OXY5741A User's Manual

Revision Date: Mar. 10. 2023

3.6.1 Administrator Password

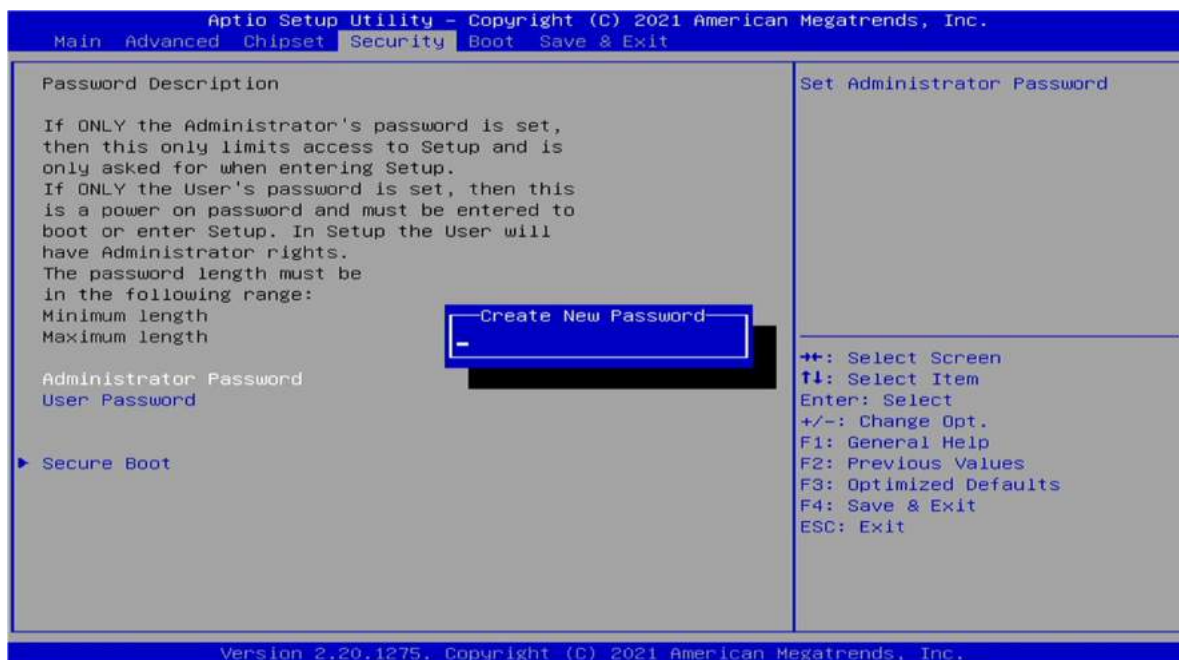
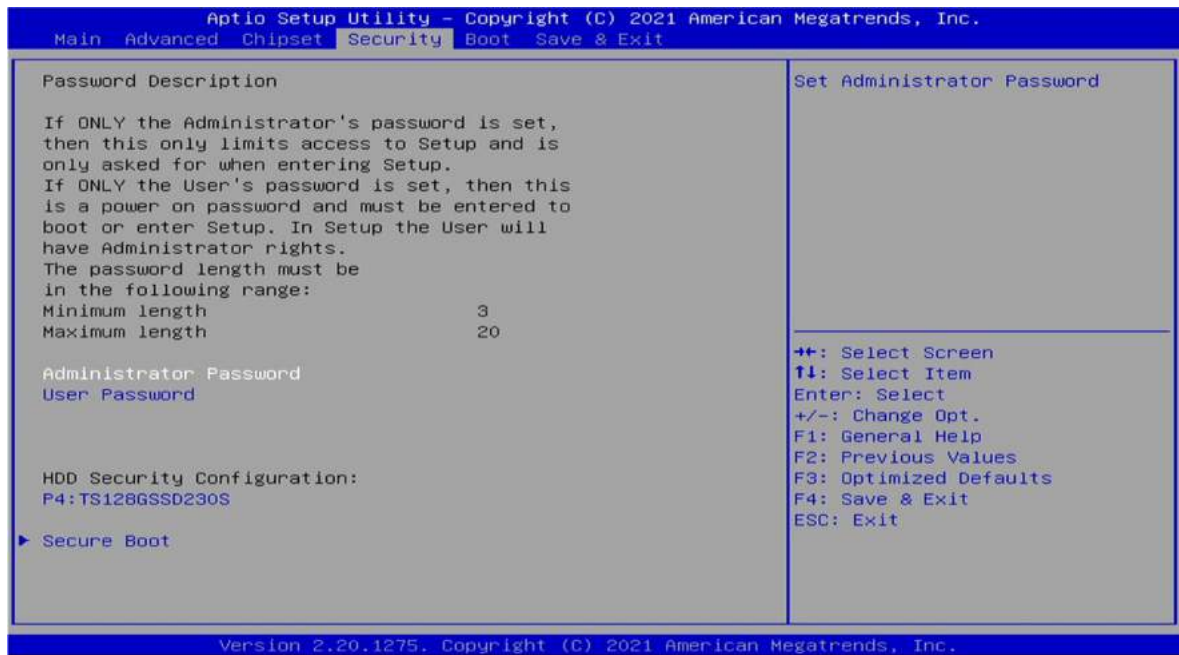

OXY5741A User's Manual

Revision Date: Mar. 10. 2023

3.6.2 User Password

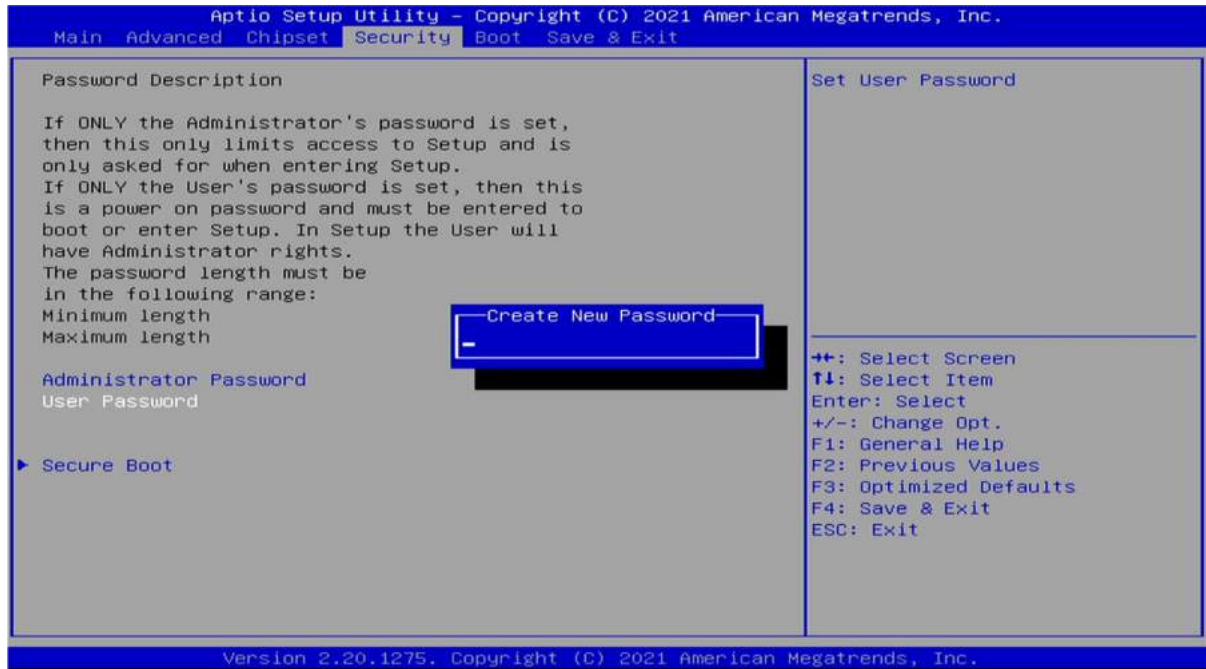

3.6.3 Secure Boot

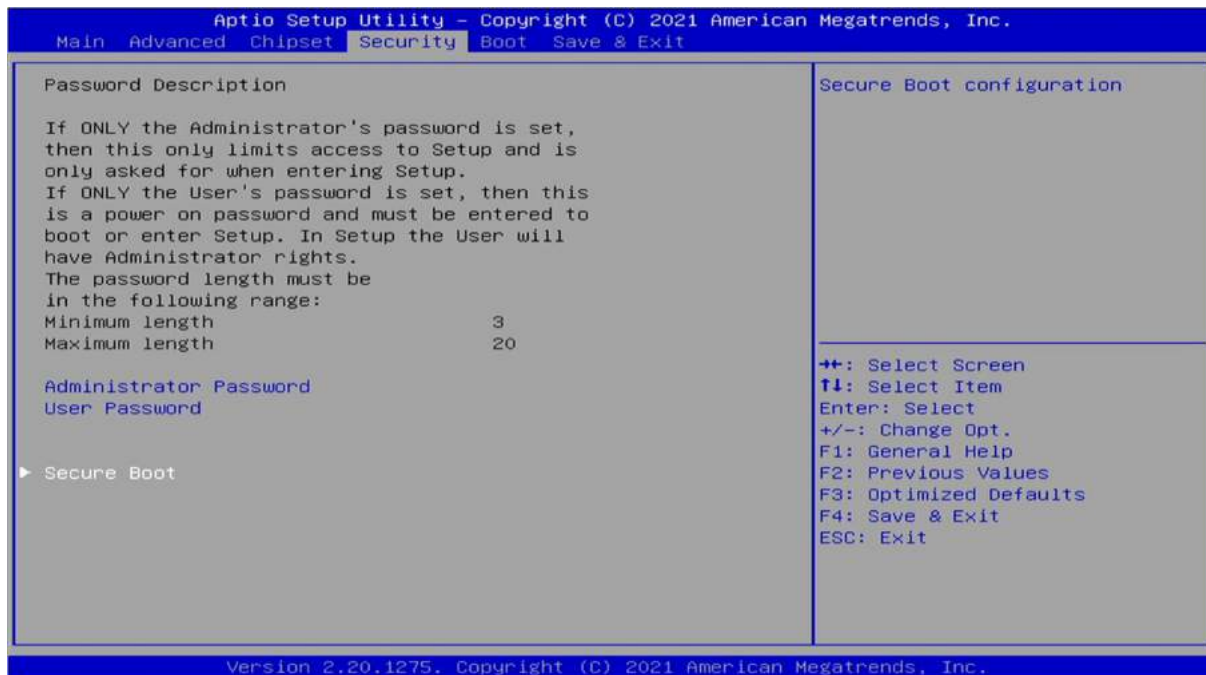

Field Name	Secure Boot
Default Value	[Disabled]
Possible Value	Disabled Enabled

Field Name	Secure Boot Mode
-------------------	-------------------------

OXY5741A User's Manual

Revision Date: Mar. 10. 2023

Default Value	[Custom]
Possible Value	Standard Custom

3.6.3.1 Restore Factory Keys

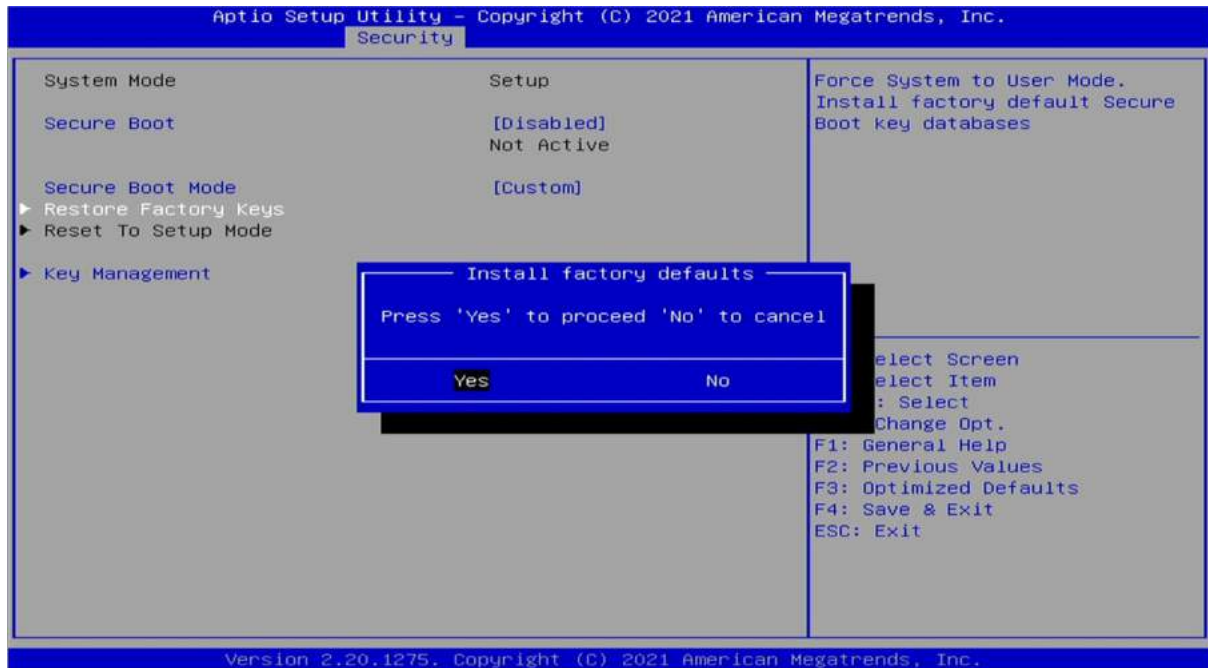

3.6.3.2 Key Management

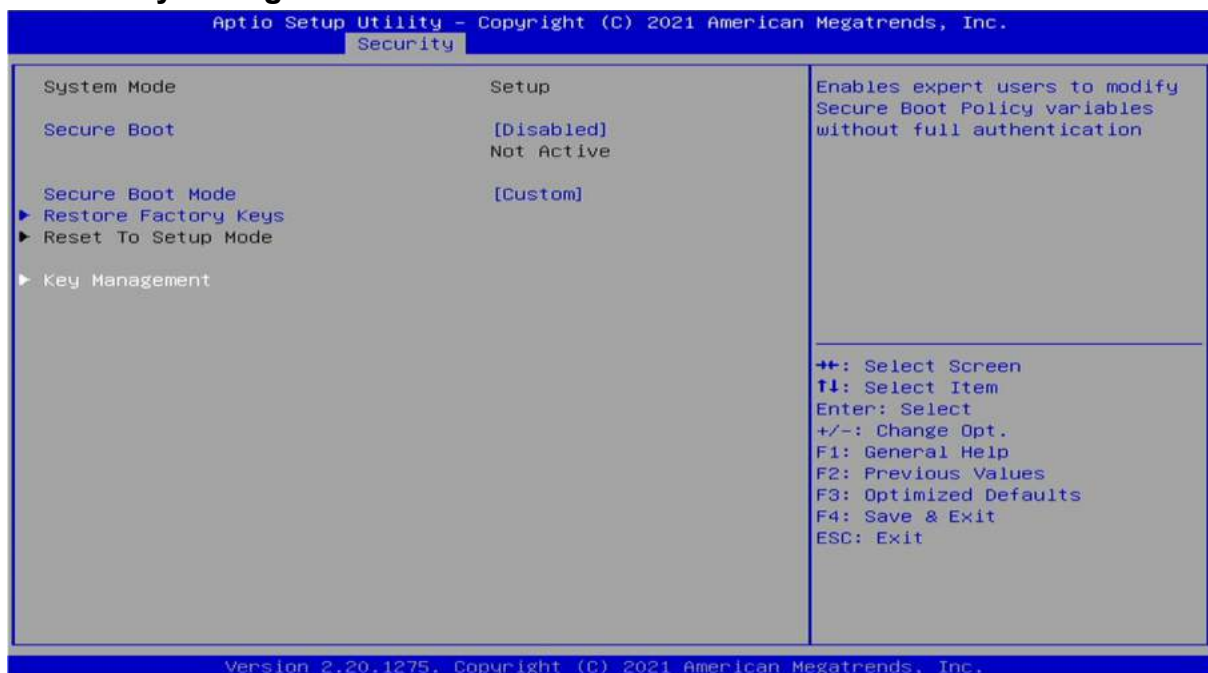

Field Name	Factory Key Provision
------------	-----------------------

OXY5741A User's Manual

Revision Date: Mar. 10. 2023

Default Value	[Disabled]
Possible Value	Disabled Enabled

3.6.3.3 Install factory defaults

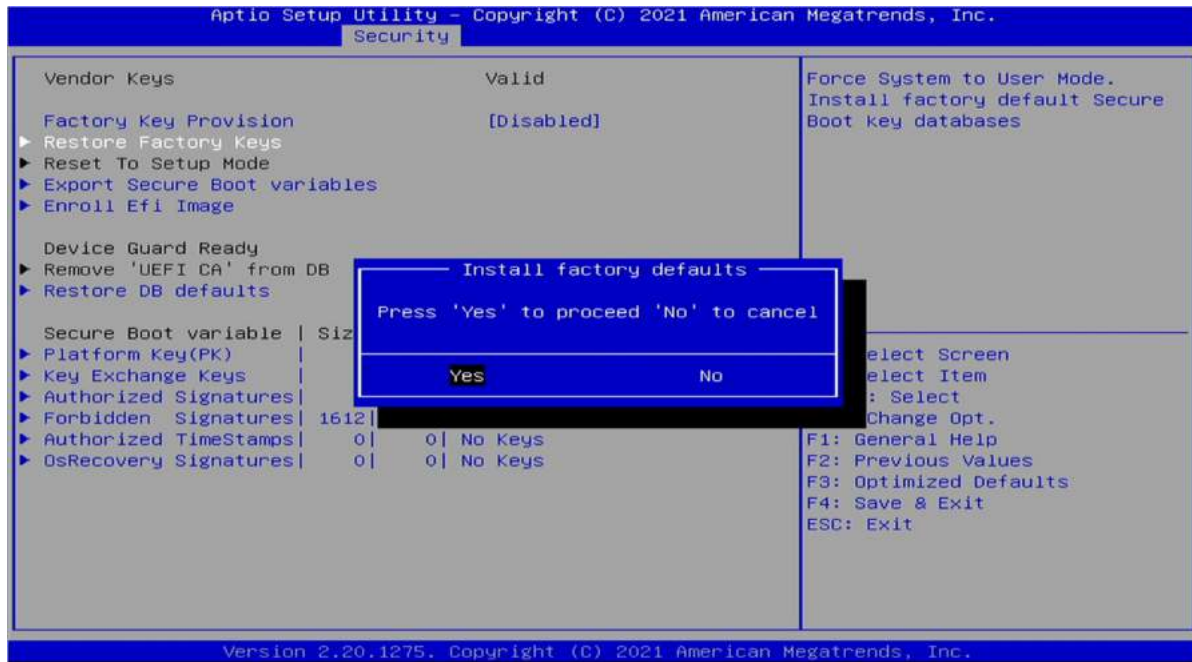

3.6.3.4 File System

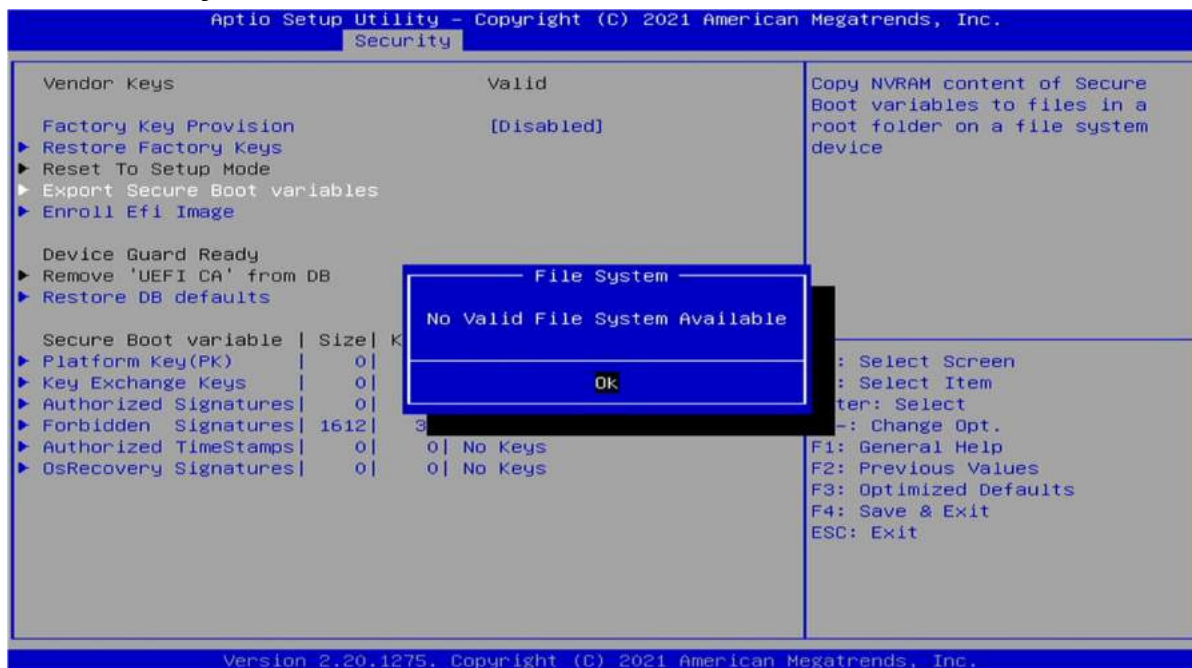

3.6.3.5 File System

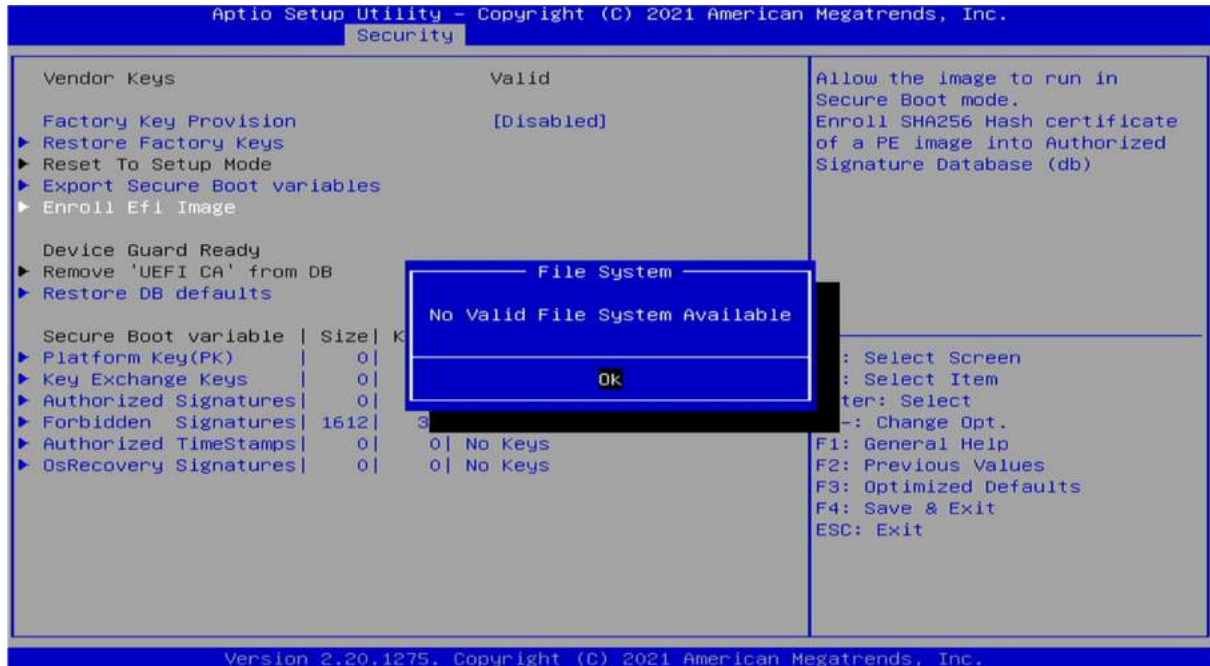

3.6.3.6 Restore DB defaults

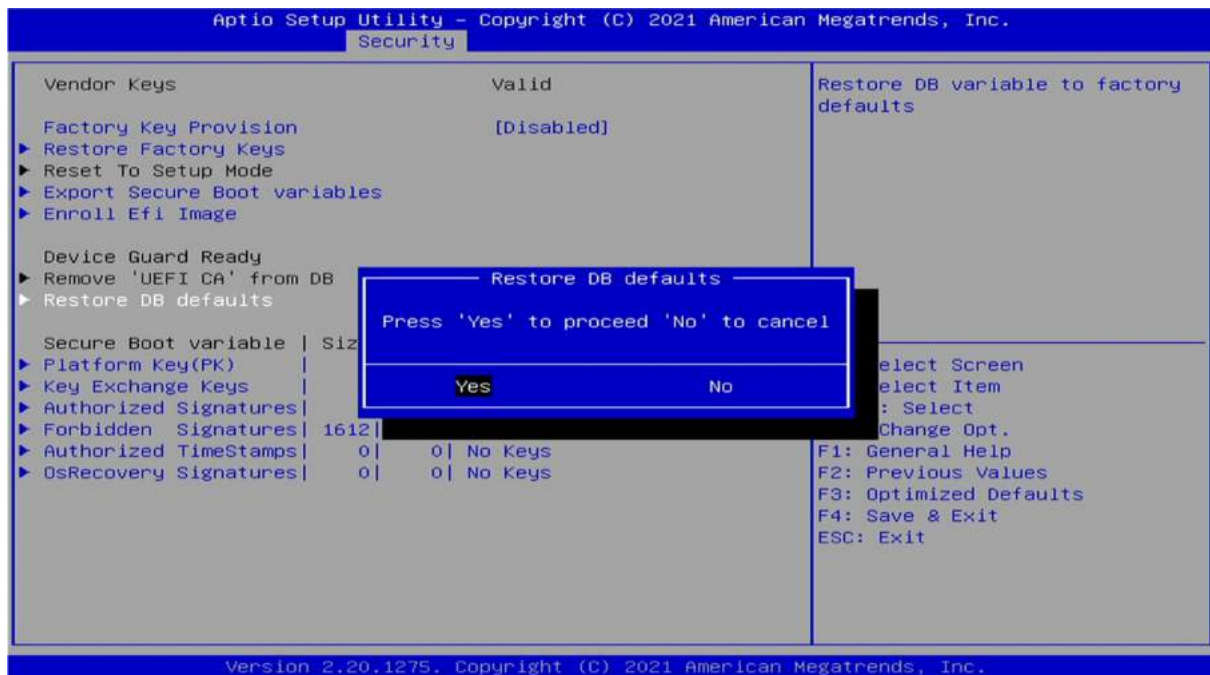

3.6.3.7 Platform Key(PK)

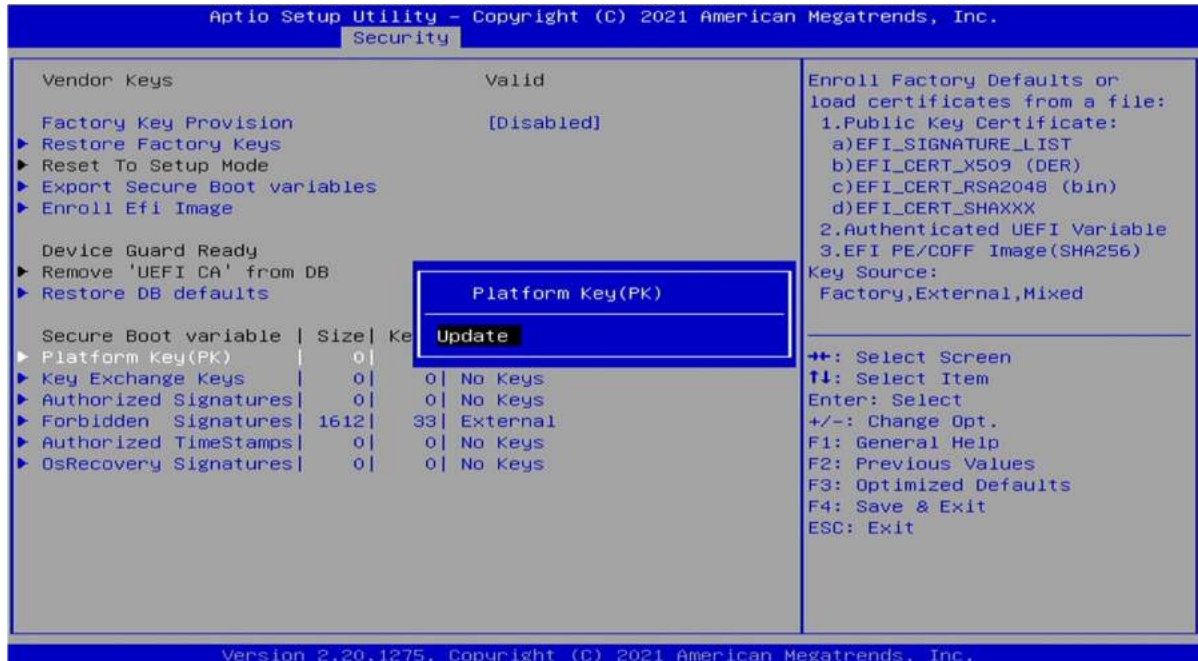

3.6.3.8 Key Exchange Kesys

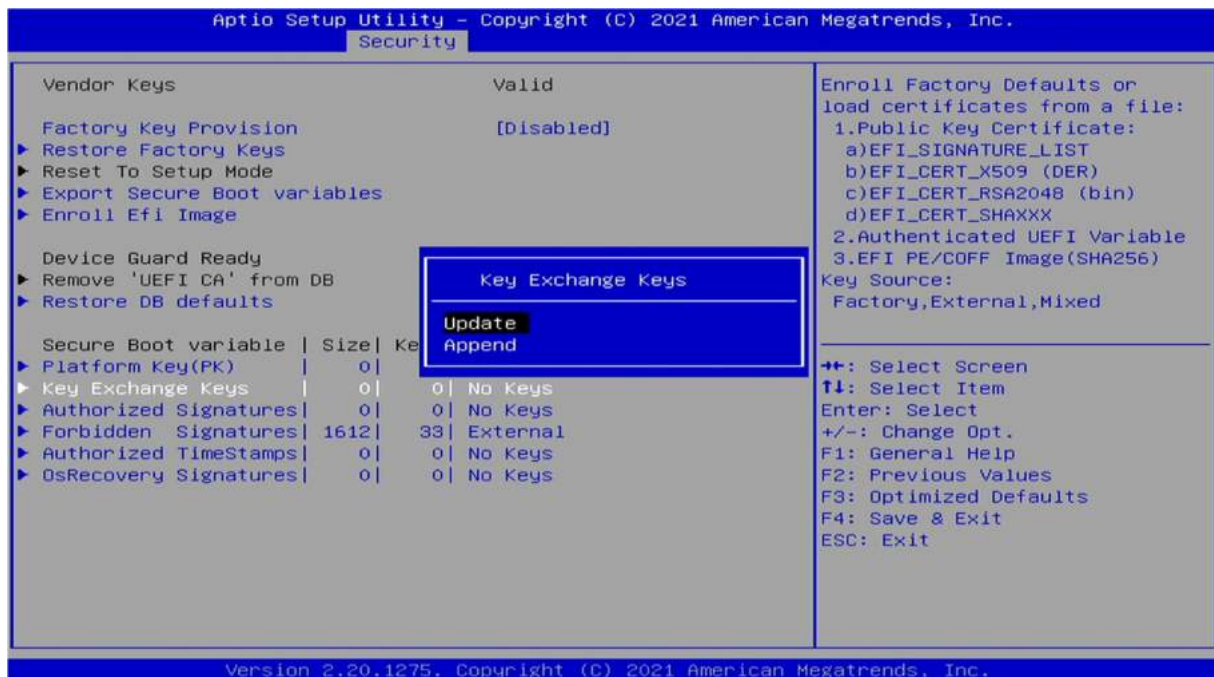

3.6.3.9 Authorized Signatures

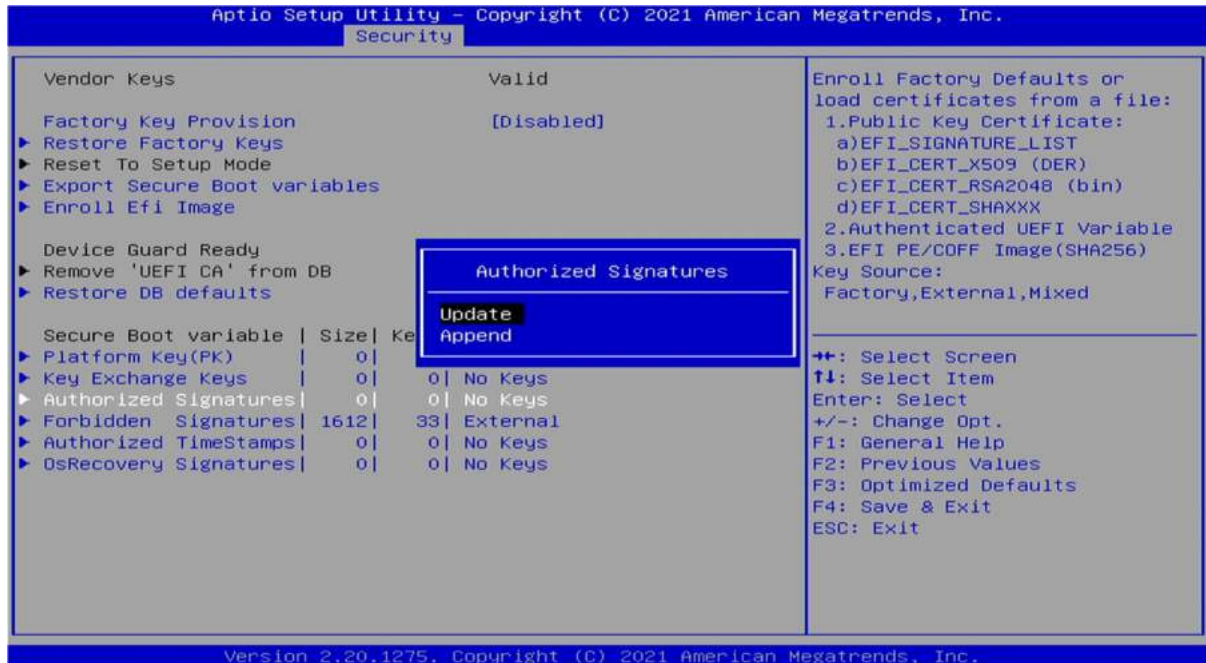

3.6.3.10 Forbidden Signatures



3.6.3.11 Authorized TimeStamps

The screenshot shows the Aptio Setup Utility Security menu. The 'Authorized TimeStamps' option is highlighted in the 'Secure Boot variable' table. A sub-menu is open over it, showing 'Update' and 'Append' options. The 'Update' option is selected.

Secure Boot variable	Size	Keys
▶ Platform Key(PK)	0	0 No Keys
▶ Key Exchange Keys	0	0 No Keys
▶ Authorized Signatures	0	0 No Keys
▶ Forbidden Signatures	1612	33 External
▶ Authorized TimeStamps	0	0 No Keys
▶ OsRecovery Signatures	0	0 No Keys

Vendor Keys Valid

Factory Key Provision [Disabled]

- ▶ Restore Factory Keys
- ▶ Reset To Setup Mode
- ▶ Export Secure Boot variables
- ▶ Enroll Efi Image

Device Guard Ready

- ▶ Remove 'UEFI CA' from DB
- ▶ Restore DB defaults

Enroll Factory Defaults or load certificates from a file:

- 1.Public Key Certificate:
 - a)EFI_SIGNATURE_LIST
 - b)EFI_CERT_X509 (DER)
 - c)EFI_CERT_RSA2048 (bin)
 - d)EFI_CERT_SHAXXX
- 2.Authenticated UEFI Variable
- 3.EFI PE/COFF Image(SHA256)

Key Source:
Factory,External,Mixed

++: Select Screen
↑↓: Select Item
Enter: Select
+/-: Change Opt.
F1: General Help
F2: Previous Values
F3: Optimized Defaults
F4: Save & Exit
ESC: Exit

Version 2.20.1275. Copyright (C) 2021 American Megatrends, Inc.

3.6.3.12 OsRecovery Signatures

The screenshot shows the Aptio Setup Utility Security menu. The 'OsRecovery Signatures' option is highlighted in the 'Secure Boot variable' table. A sub-menu is open over it, showing 'Update' and 'Append' options. The 'Update' option is selected.

Secure Boot variable	Size	Keys
▶ Platform Key(PK)	0	0 No Keys
▶ Key Exchange Keys	0	0 No Keys
▶ Authorized Signatures	0	0 No Keys
▶ Forbidden Signatures	1612	33 External
▶ Authorized TimeStamps	0	0 No Keys
▶ OsRecovery Signatures	0	0 No Keys

Vendor Keys Valid

Factory Key Provision [Disabled]

- ▶ Restore Factory Keys
- ▶ Reset To Setup Mode
- ▶ Export Secure Boot variables
- ▶ Enroll Efi Image

Device Guard Ready

- ▶ Remove 'UEFI CA' from DB
- ▶ Restore DB defaults

Enroll Factory Defaults or load certificates from a file:

- 1.Public Key Certificate:
 - a)EFI_SIGNATURE_LIST
 - b)EFI_CERT_X509 (DER)
 - c)EFI_CERT_RSA2048 (bin)
 - d)EFI_CERT_SHAXXX
- 2.Authenticated UEFI Variable
- 3.EFI PE/COFF Image(SHA256)

Key Source:
Factory,External,Mixed

++: Select Screen
↑↓: Select Item
Enter: Select
+/-: Change Opt.
F1: General Help
F2: Previous Values
F3: Optimized Defaults
F4: Save & Exit
ESC: Exit

Version 2.20.1275. Copyright (C) 2021 American Megatrends, Inc.

3.7 Boot



Field Name	Bootup NumLock State
Default Value	[Off]
Possible Value	On Off

Field Name	Quiet Boot
Default Value	[Enabled]
Possible Value	Disabled Enabled

Field Name	Fast Boot
Default Value	[Disable Link]
Possible Value	Disable Link Enabled

3.8 Save & Exit

3.8.1 Save Changes and Exit



3.8.1.1 Save & Exit Setup

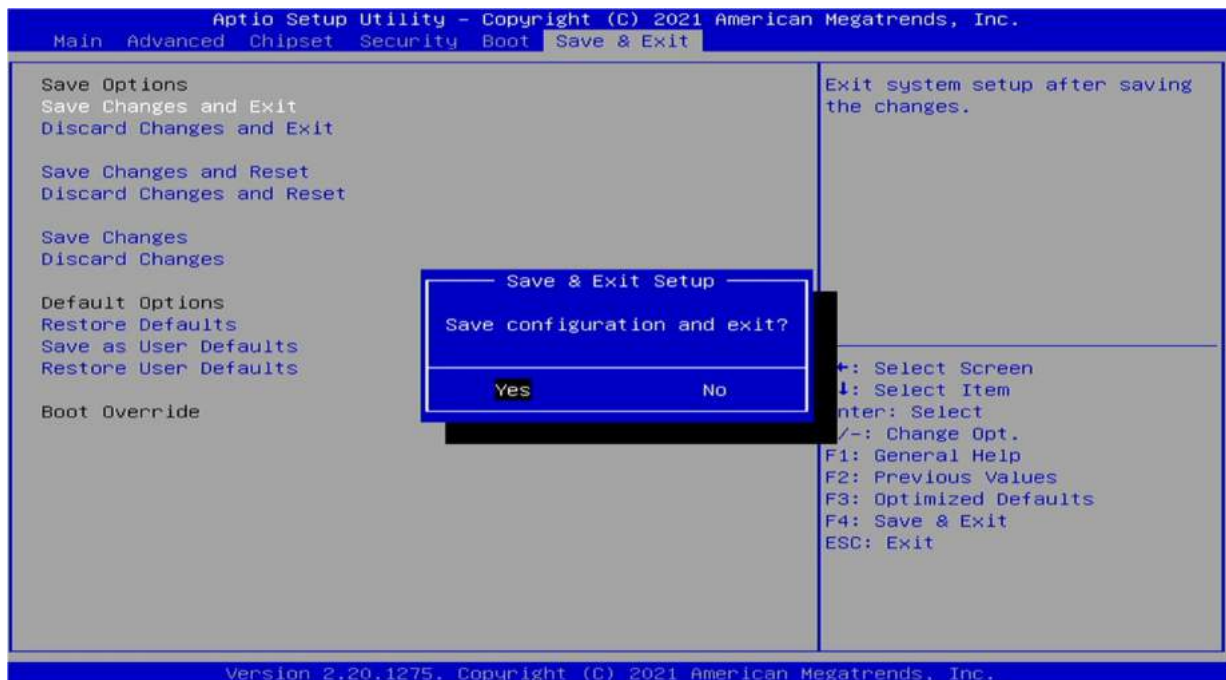

OXY5741A User's Manual

Revision Date: Mar. 10. 2023

3.8.2 Exit Without Saving

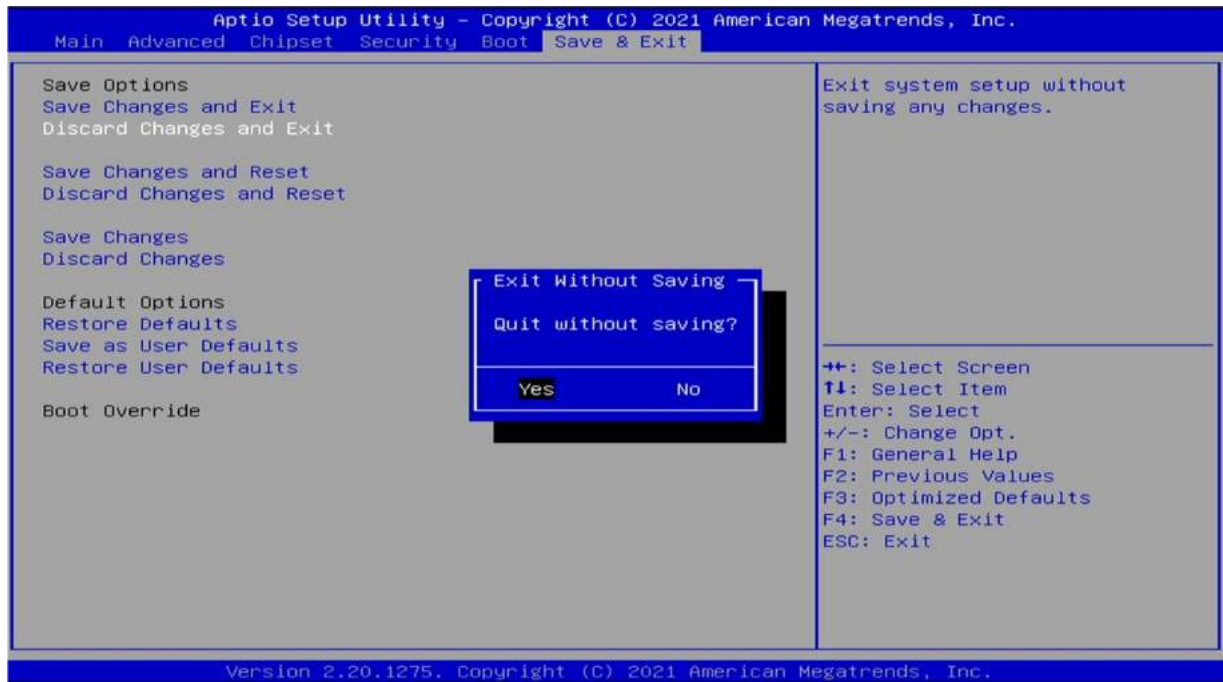

3.8.3 Save & reset

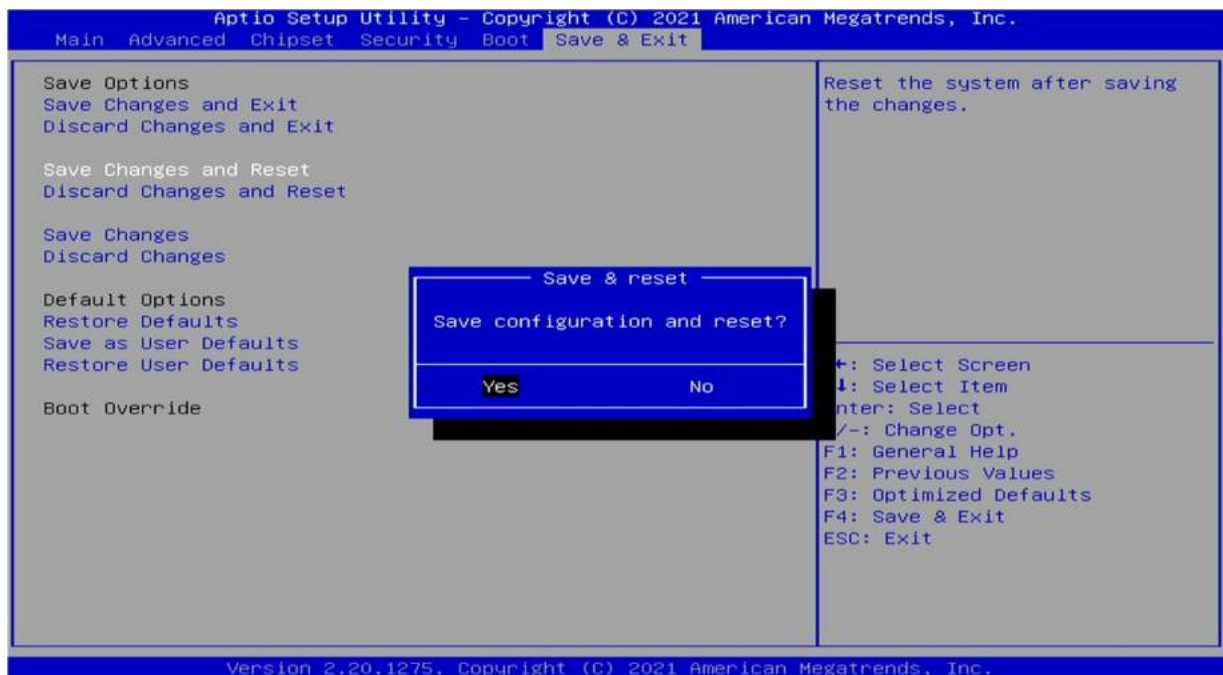

OXY5741A User's Manual

Revision Date: Mar. 10. 2023

3.8.4 Reset Without Saving

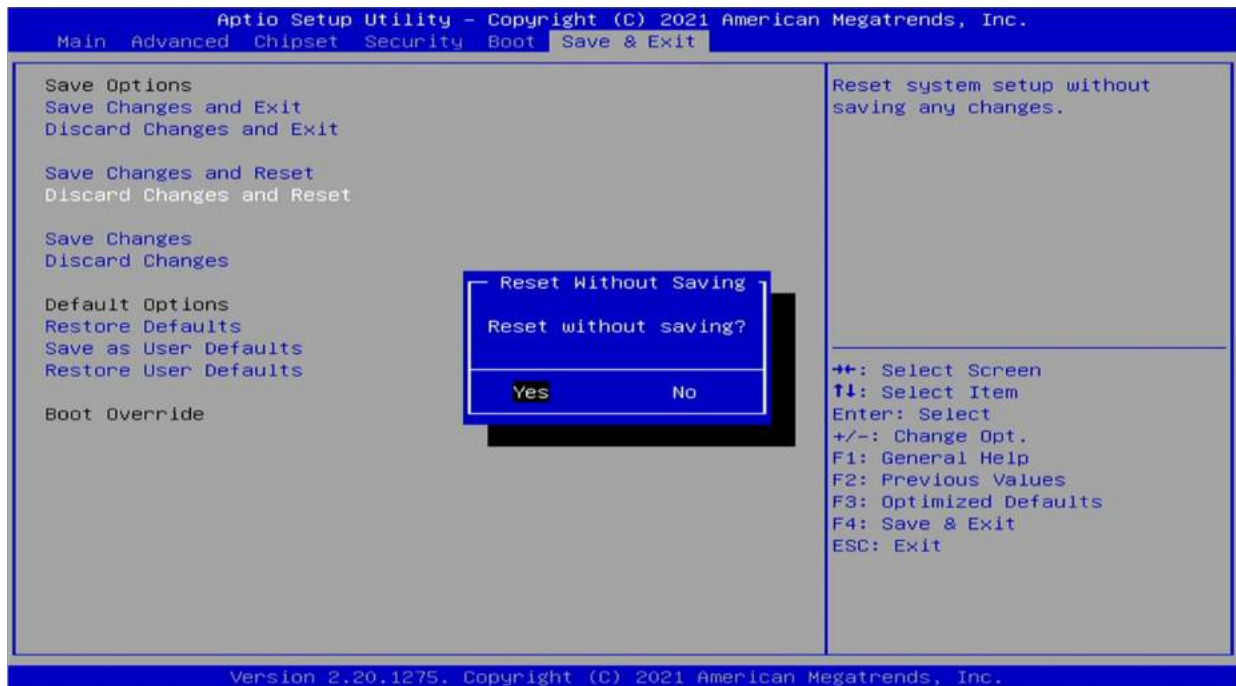

3.8.5 Save Setup Values

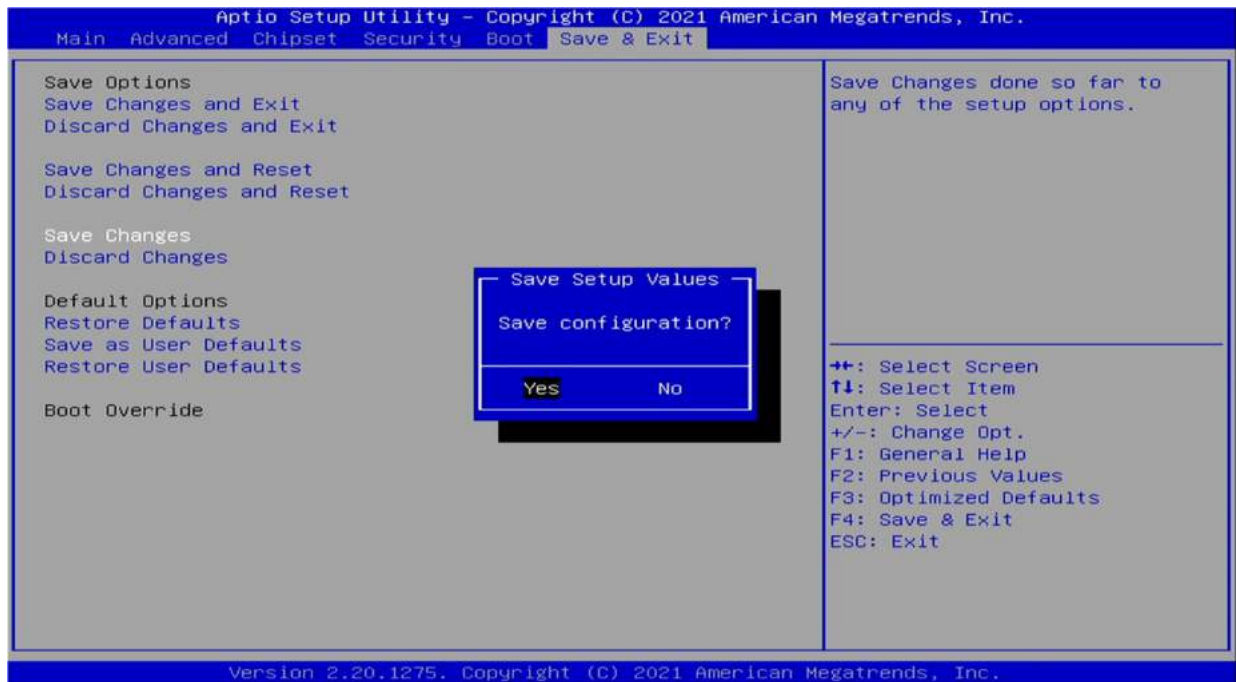

3.8.6 Load Previous Values

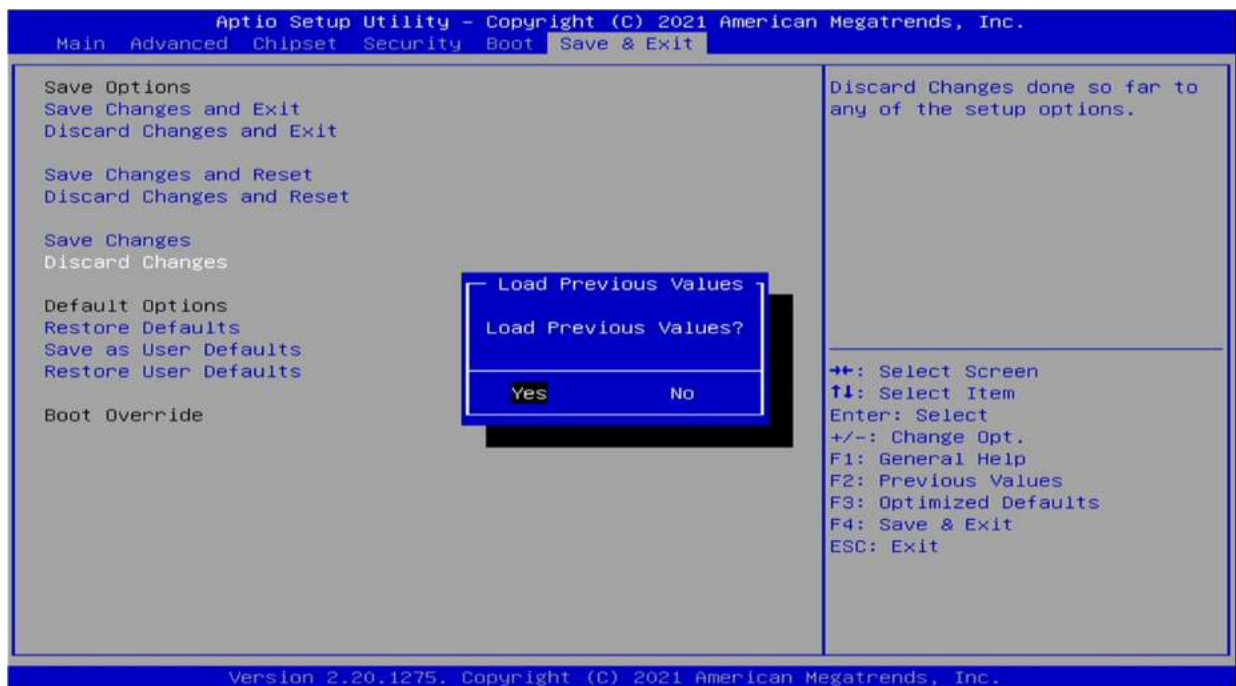

3.8.7 Load Optimized Defaults

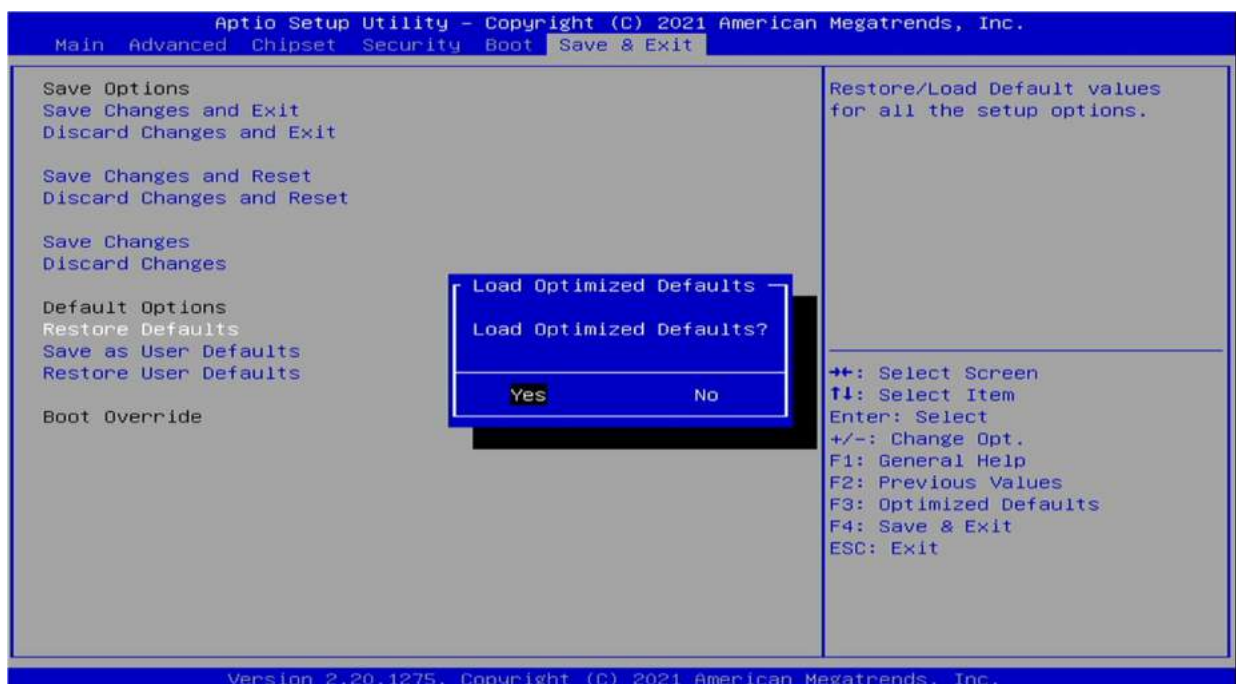

3.8.8 Save Values as User Defaults



3.8.9 Restore User Defaults

