



INS8367A

Intel® Raptor Lake-S/ Alder Lake-S

13th/12th Processor With H610/Q670

Chipset Mini-ITX



User's Manual

Revision Date: Sep. 01. 2023

Safety Information

Electrical safety

- To prevent electrical shock hazard, disconnect the power cable from the electrical outlet before relocating the system.
- When adding or removing devices to or from the system, ensure that the power cables for the devices are unplugged before the signal cables are connected. If possible, disconnect all power cables from the existing system before you add a device.
- Before connecting or removing signal cables from the motherboard, ensure that all power cables are unplugged.
- Seek professional assistance before using an adapter or extension cord. These devices could interrupt the grounding circuit.
- Make sure that your power supply is set to the correct voltage in your area.
- If you are not sure about the voltage of the electrical outlet you are using, contact your local power company.
- If the power supply is broken, do not try to fix it by yourself. Contact a qualified service technician or your local distributor.

Operation safety

- Before installing the motherboard and adding devices on it, carefully read all the manuals that came with the package.
- Before using the product, make sure all cables are correctly connected and the power cables are not damaged. If you detect any damage, contact your dealer immediately.
- To avoid short circuits, keep paper clips, screws, and staples away from connectors, slots, sockets and circuitry.
- Avoid dust, humidity, and temperature extremes. Do not place the product in any area where it may become wet.
- Place the product on a stable surface.
- If you encounter any technical problems with the product, contact your local distributor

Statement

- All rights reserved. No part of this publication may be reproduced in any form or by any means, without prior written permission from the publisher.
- All trademarks are the properties of the respective owners.
- All product specifications are subject to change without prior notice

RoHS Compliance



Perfectron RoHS Environmental Policy and Status Update

Perfectron is a global citizen for building the digital infrastructure. We are committed to providing green products and services, which are compliant with

European Union RoHS (Restriction on Use of Hazardous Substance in Electronic Equipment) directive 2011/65/EU, to be your trusted green partner and to protect our environment.

In order to meet the RoHS compliant directives, Perfectron has established an engineering and manufacturing task force to implement the introduction of green products. The task force will ensure that we follow the standard Perfectron development procedure and that all the new RoHS components and new manufacturing processes maintain the highest industry quality levels for which Perfectron are renowned.

The model selection criteria will be based on market demand. Vendors and suppliers will ensure that all designed components will be RoHS compliant.

Revision History

Revision	Date (yyyy/mm/dd)	Changes
V1.0	2023/07/05	First release
V1.1	2023/09/01	Remove Front Audio support

Packing List

Item	Description	Q'ty
1	INS8367A	1
2	CD(Driver + User's manual)	1
3	2 x IO Bracket(Half and Full Height)	1
4	SATA Cable	1
5	SATA Power Cable	1



If any of the above items is damaged or missing, please contact your local distributor.

Table of Contents

Safety Information	1
Electrical safety	1
Operation safety	1
Statement	1
RoHS Compliance	2
Revision History	3
Packing List	3
Chapter 1 : Product Introduction	6
1.1 Specifications	6
1.2 Block Diagram	9
1.3 Board Placement	10
Chapter 2 : Jumpers and Connectors Location	11
2.1 Jumpers And Connectors List	11
2.2 Jumper Setting	12
Chapter 3 : AMI BIOS UTILITY	16
3.1 Staring	16
3.2 Navigation Keys	16
3.3 Main Page	17
3.4 Advance Page	20
3.4.1 Onboard Device	22
3.4.2 CPU Configuration	24
3.4.3 VMD setup menu	25
3.4.4 Trusted Computing	26
3.4.5 Super IO Configuration	27
3.4.6 Serial Port 1 Configuration	28
3.4.7 Serial Port 2 Configuration	30
3.4.8 Hardware Monitor	31
3.4.9 S5 RTC Wake Settings	33
3.4.10 Network Stack Configuration	34
3.4.11 NVMe Configuration	35
3.5 Security Page	36
3.5.1 HDD Security	37
3.5.2 Secure Boot	38
3.5.3 Key Management	39

3.6 Boot Page	44
3.6.1 (List Boot Device Type)Drive BBS Priorites	47
3.7 Save & Exit Page.....	48
3.8 Event Logs.....	49
3.8.1 Change Smbios Event Log Setting	50
3.8.2 View Smbios Event Log	51

Chapter 1 : Product Introduction

1.1 Specifications

System

CPU	13 th / 12 th Gen Intel® Raptor Lake-S/ Alder Lake-S LGA1700 Socket Processor / Core i9/i7/i5/i3 Processor, 65W
System Memory	DDR4 3200MHz / 2 x 260-pin SO-DIMM / Max. 64GB (Non-ECC) Vertical
Chipset	Intel® H610/Q670
Graphics	Intel® UHD Graphics
I/O Chipset	Nuvoton NCT6126D
TPM	TPM Header
BIOS	AMI
Watchdog Timer	1-255 sec. or 1-255 min. software programmable and can be generate system reset

Expansion

M.2	1 x M.2 2280 M-Key (PCIe 3.0 X4 , SATAIII)
PCIe Slot	1 x PCIe 4.0 X16 slot

Display

Display Port	Up to 4K (4096 x 2304) @60 Hz
2nd Display Port	Up to 4K (4096 x 2304) @60 Hz

Ethernet

Chipset	Intel® I219-LM GbE LAN + Intel® I225V 2.5 GbE LAN
---------	---

Rear I/O

USB	2 x USB3.1 ; 2 x USB2.0
Display port	2 x DP
LAN	2(1 x GbE ; 1 x 2.5GbE)

INS8367A User's Manual v1.1

Revision Date: Sep. 01. 2023

Internal I/O

SATAIII	3
USB3.1	2
USB2.0	2
Serial	2 (1 x Support RS-232/422/485)
FAN	1 x 4-pin CPU Fan Connector / 1 x 4-pin System Fan Header
Power	1 x 12V DC IN Jack(Colay 19V) 1 x ATX 4pin (AT/ATX mode by jumper setting)
Others	1 x CMOS Jumper, 1 x SATA power, 1 x FIO header 1 x intrusion switch header

Environmental

Form Factor	Mini ITX
Power Type	12V DC-IN
Dimension	170mm x 170mm
Operating Temperature	ET : -20°C ~ 70°C UT : -40°C ~ 85°C
Storage Temperature	-40°C ~ 85°C
Relative humidity	10% to 95%,non-condensing

Standard Compliance

Standard Compliance	CE / FCC
---------------------	----------

OS

OS Support	Windows®10 64-bit Linux(Support by request)
------------	--

1.2 Block Diagram

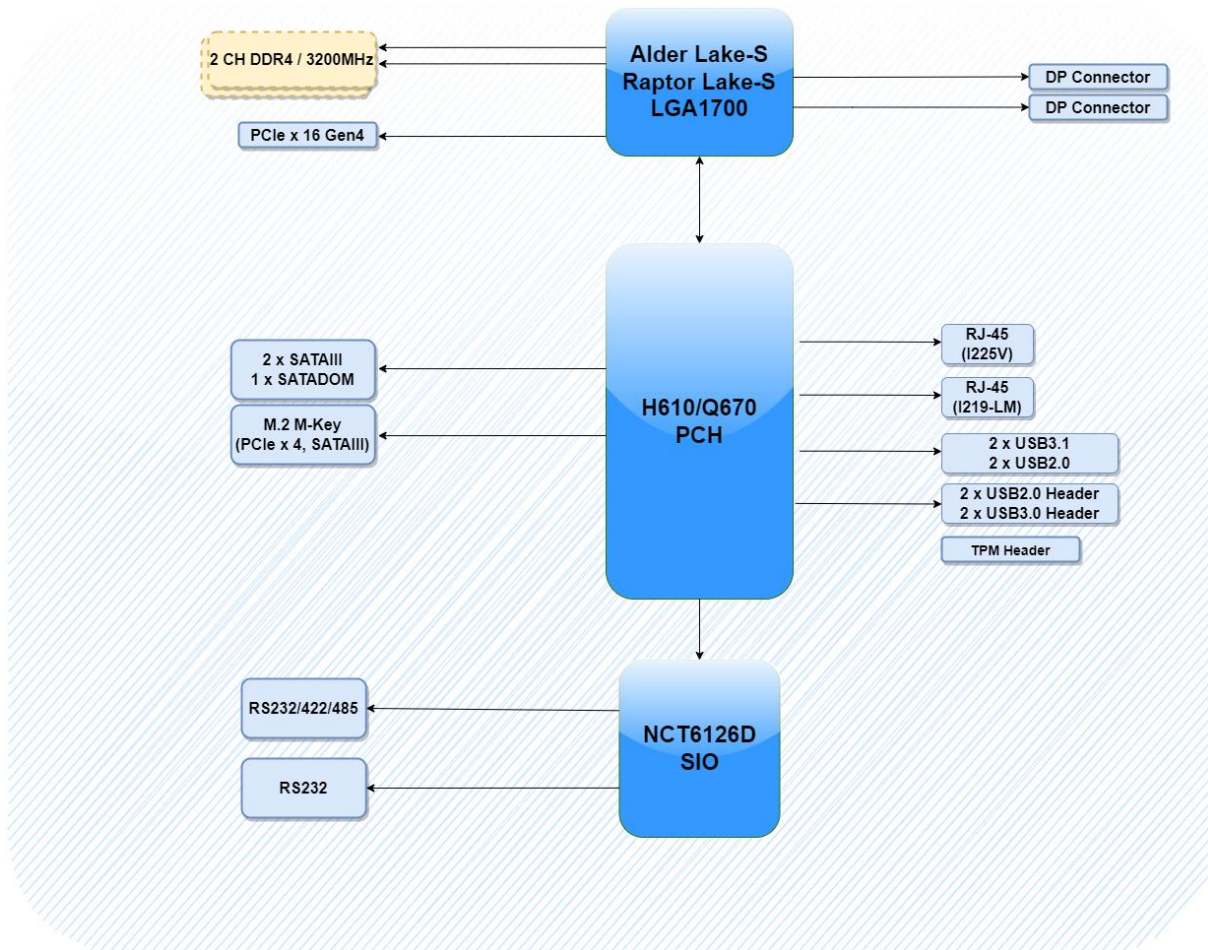

1.3 Board Placement

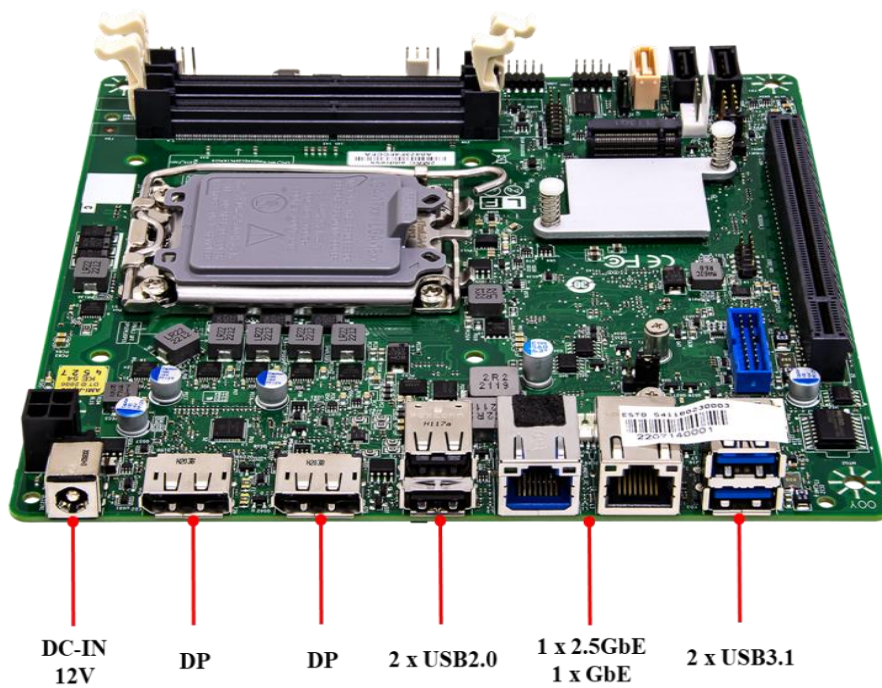
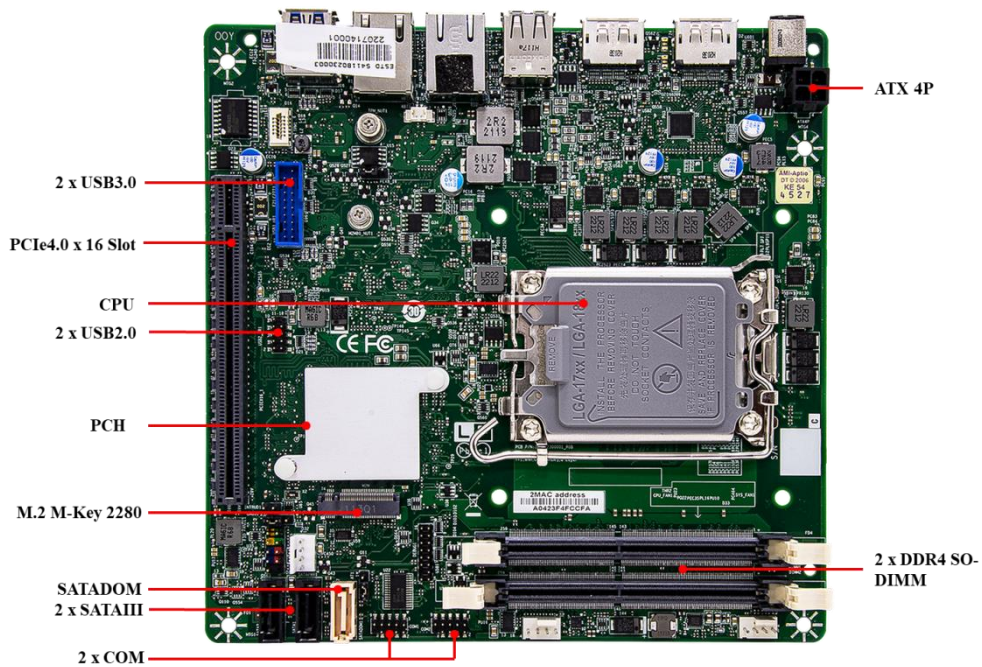

Chapter 2 : Jumpers and Connectors Location

2.1 Jumpers and Connectors List

Label	Function
1	USB3.0 Header
2	USB Header
3	Intruder Header
4	Front Panel Header
5	SATA
6	SATA Power Header
7	SATA
8	SATADOM
9	COM1
10	COM2
11	P2398 Card Header
12	CPU FAN Header
13	System Fan Header
14	ATX 4pin
15	TPM Header
16	Clear CMOS Header
17	AT/ATX Select Header
18	PCIe x 16 /8 Select Header
19	LGA1700 CPU Socket
20	PCH
21	2 x DDR4 SO-DIMM Socket
22	M.2 2280 M-Key

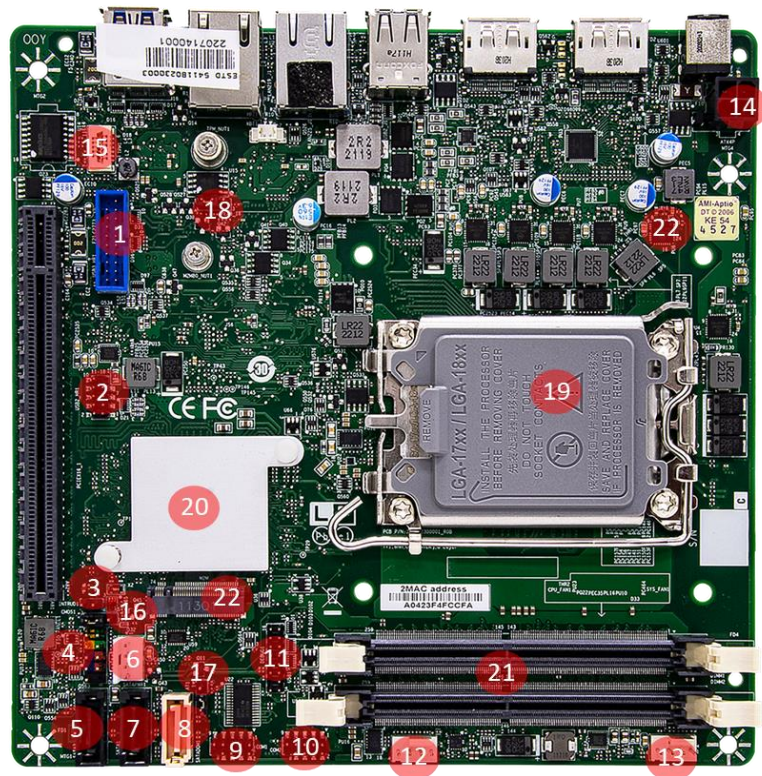

2.2 Jumper Settings

Front Panel Header

PIN	DEFINITION	PIN	DEFINITION
1	HDD_POWER_LED	2	POWER_LED_MAIN
3	HDD_LED#	4	POWER_LED_ALT
5	GND	6	POWER_SWITCH#
7	RESET_SWITCH#	8	GND
9	+5V_DC	10	Key(no pin)

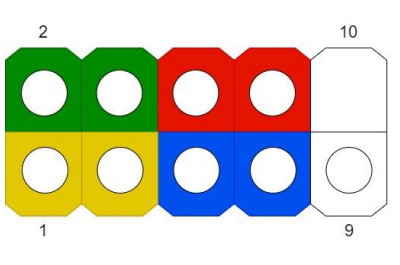

ATX Power Input Header

PIN	DEFINITION	PIN	DEFINITION
1	GND	2	DC12V_IN
3	GND	4	DC12V_IN

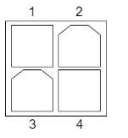

TPM Header

PIN	DEFINITION	PIN	DEFINITION
1	SPI_CLK	7	3VSB
2	PLTRST_N	8	TPM_DET
3	SPI_MOSI	9	TPM_PIRQ_N
4	SPI_MISO	10	VCC3_TPM
5	SPI_CS2_N	11	GND
6	NC		

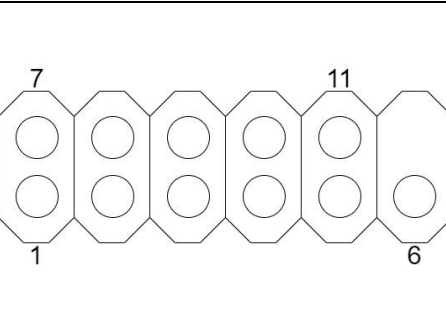

CPU/SYS FAN Header

PIN	DEFINITION
1	GND
2	+12V
3	CPU_FAN_TACH
4	CPU_FAN_CTRL

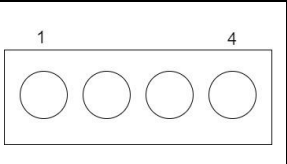

Serial Port Pin-Out(COM1/COM2)

PIN	DEFINITION	PIN	DEFINITION
1	DCD	2	RXD#
3	TXD#	4	DTR
5	GND	6	DSR
7	RTS	8	CTS
9	RI	10	Key(no pin)

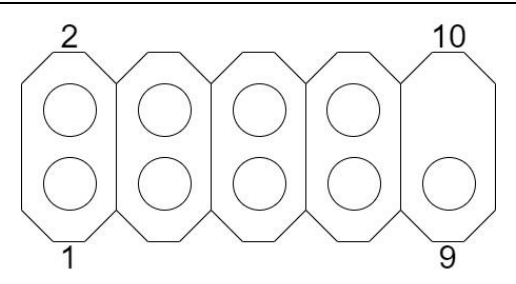

Debug : P2398 Card Header

PIN	DEFINITION	PIN	DEFINITION
1	GND	2	VCC (5V)
3	Power Button	4	KEY
5	PORT80_A	6	3VSB
7	PORT80_B	8	PORT80_E
9	PORT80_C	10	PORT80_F
11	PORT80_D	12	PORT80_G
13	PORT80_DGH	14	PORT80_DGL
15	Dip switch_GPIO42	16	Dip switch_GPIO43

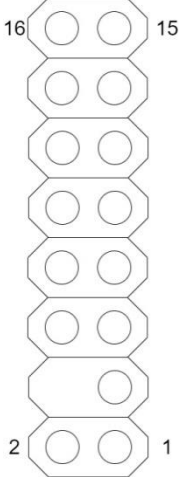

AT/ATX Mode Jumper

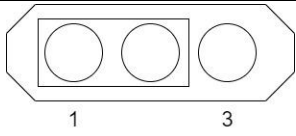
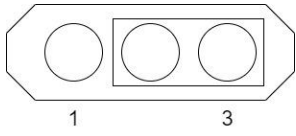
PIN	DEFINITION	
1-2	AT Mode	
2-3	ATX Mode(Default)	

SATA Power Header

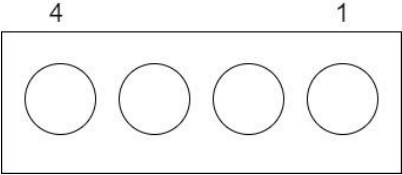
PIN	DEFINITION	
1	12V	
2	GND	
3	GND	
4	VCC(5V)	

INTRUDER Header

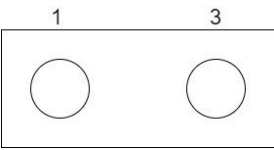
PIN	DEFINITION	
1	INTRUDER_N	
2	Key(no pin)	
3	GND	

Dual USB2.0 Header

PIN	DEFINITION	PIN	DEFINITION
1	5V_USB2_FP	2	5V_USB2_FP
3	USB2_HR1_1N	4	USB2_HR1_2N
5	USB2_HR1_1P	6	USB2_HR1_2P
7	GND	8	GND
9	Key (no pin)	10	No Connect

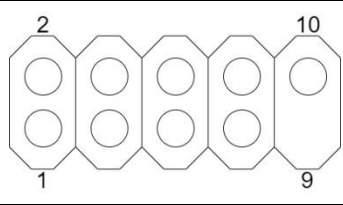

Dual USB3.0 Header

PIN	DEFINITION	PIN	DEFINITION
1	5V_USB3_FP	20	Key(no pin)
2	USB3P4_RXN-	19	5V_USB3_FP
3	USB3P4_RXP	18	USB3P3_RXP
4	GND	17	USB3P3_RXP
5	USB3P4_TXN_C-	16	GND
6	USB3P4_TXP_C	15	USB3P3_TXN_C
7	GND	14	USB3P3_TXP_C
8	USB_PCH_C_DN5	13	GND
9	USB_PCH_C_DP5	12	USB_PCH_C_DN6
10	NC	11	USB_PCH_C_DP6

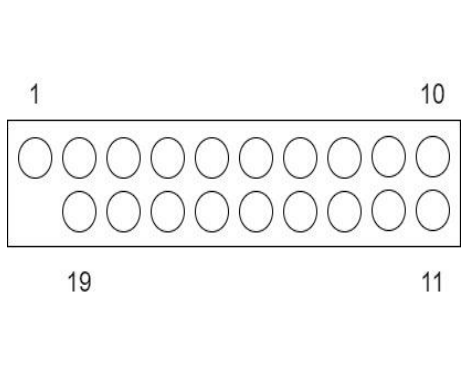

Serial Port Pin-Out(COM2)

PIN	RS232	RS422	RS485
1	DCD	NC	NC
2	RXD#	NC	NC
3	TXD#	NC	NC
4	DTR	NC	NC
5	GND	NC	NC
6	DSR	NC	NC
7	RTS	NC	NC
8	CTS	NC	NC
9	RI	NC	NC
10	Key(no pin)	NC	NC

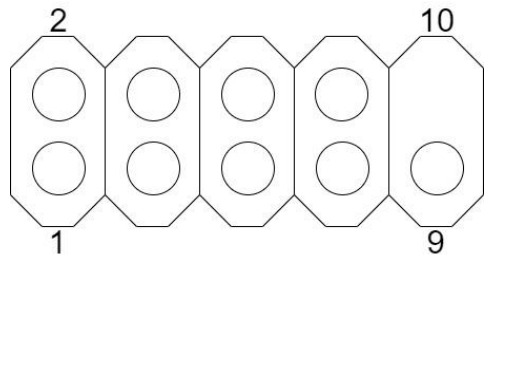

Clear CMOS Header

PIN	DEFINITION
1-2	Normal(Default)
2-3	Clear CMOS

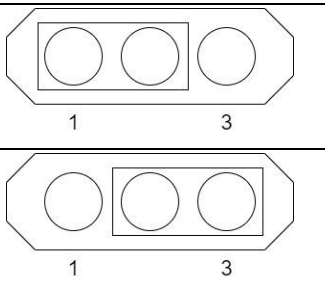

PEX8_16: PEX8 or PCIEX16 Select Header

PIN	DEFINITION
1	Pull High
2	DFG[5]: PCI Express Bifurcation High: 1 x16 PCI Express* (Default) Low: 2 x8 PCI Express
3	Pull Low

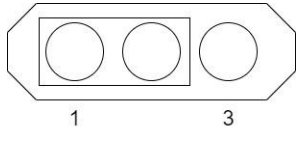
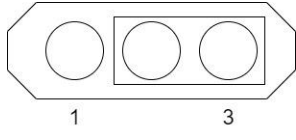
PIN	DEFINITION	
1-2	Pins 1&2 closed: High: 1 x16 PCI Express* (Default)	 <p>The diagram shows a three-pin header with pins 1, 2, and 3. Pins 1 and 2 are connected by a bridge, while pin 3 is open. The pins are labeled 1 and 3 below the header.</p>
2-3	Pins 2&3 closed: Low: 2 x8 PCI Express	 <p>The diagram shows a three-pin header with pins 1, 2, and 3. Pin 1 is open, while pins 2 and 3 are connected by a bridge. The pins are labeled 1 and 3 below the header.</p>

Chapter 3: AMI BIOS UTILITY

This chapter provides users with detailed descriptions on how to set up a basic system configuration through the AMI BIOS setup utility.

3.1 Starting

To enter the setup screens, perform the following steps:

- Turn on the computer and press the key immediately.
- After the key is pressed, the main BIOS setup menu displays. Other setup screens can be accessed from the main BIOS setup menu, such as the Chipset and Power menus.

3.2 Navigation Keys

The BIOS setup/utility uses a key-based navigation system called hot keys. Most of the BIOS setup utility hot keys can be used at any time during the setup navigation process. Some of the hot keys are <F1>, <F10>, <Enter>, <ESC>, and <Arrow> keys.



Some of the navigation keys may differ from one screen to another.

Left/Right	The Left and Right <Arrow> keys moves the cursor to select a menu.
Up/Down	The Up and Down <Arrow> keys moves the cursor to select a setup screen or sub-screen.
+– Plus/Minus	The Plus and Minus <Arrow> keys changes the field value of a particular setup setting.
Tab	The <Tab> key selects the setup fields.
F1	The <F1> key displays the General Help screen.
F10	The <F10> key saves any changes made and exits the BIOS setup utility.
Esc	The <Esc> key discards any changes made and exits the BIOS setup utility.
Enter	The <Enter> key displays a sub-screen or changes a selected or highlighted option in each menu.

3.3 Main Page

In this section, you can alter general features such as the date and time.

Note that the options listed below are for options that can directly be changed within the Main Setup screen.

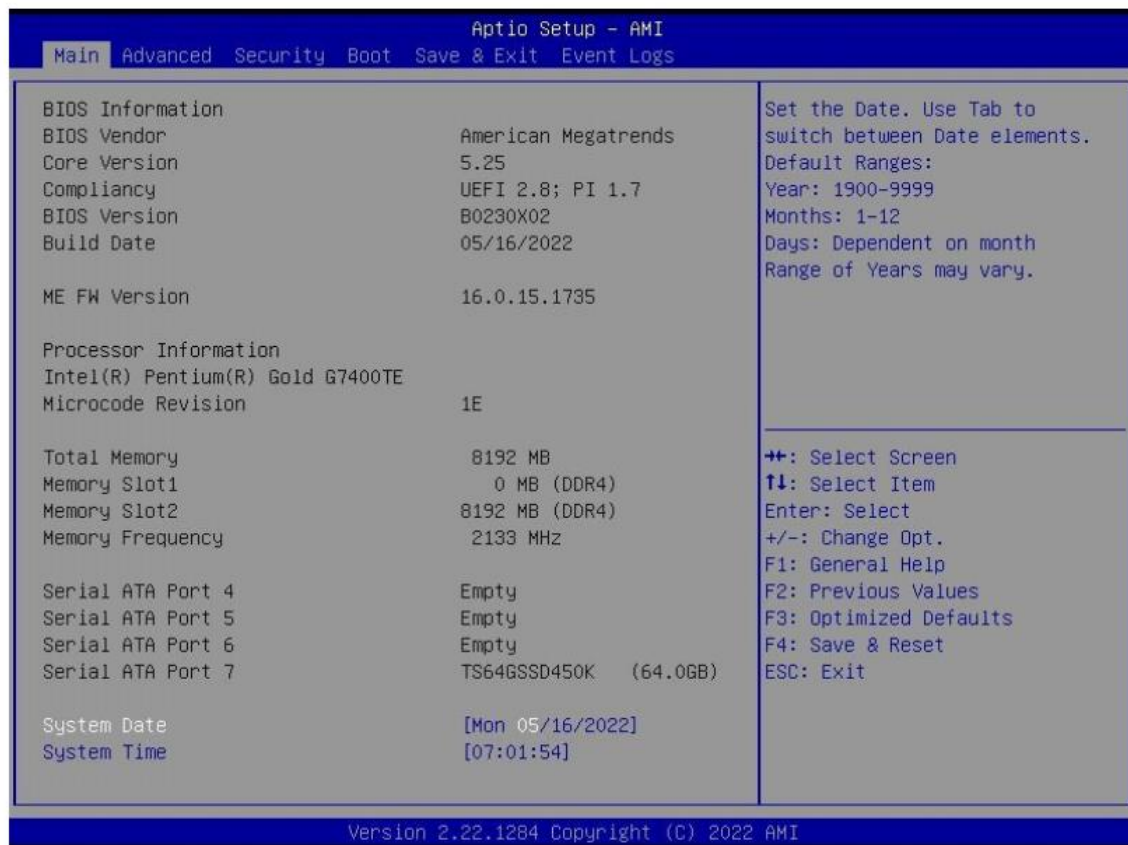

Field Name	BIOS Vender
Default Value	American Megatrends
Comment	This field is not selectable. There is no help text associated with it.

Field Name	Core Version
Default Value	5.24
Comment	This field is not selectable. There is no help text associated with it

Field Name	Compliance
Default Value	UEFI 2.8 ; PI 1.6
Comment	This field is not selectable. There is no help text associated with it

Field Name	BIOS Version
Default Value	Display the version of the BIOS
Comment	This field is not selectable. There is no help text associated with it

Field Name	Build Date
Default Value	Display build date of the BIOS
Comment	This field is not selectable. There is no help text associated with it.

Field Name	ME FW Version
Default Value	ME Firmware Version.
Comment	This field is not selectable. There is no help text associated with it.

Field Name	Processor Information
Default Value	Display the installed CPU brand.
Comment	This field is not selectable. There is no help text associated with it.

Field Name	Microcode Version
Default Value	Display the CPU microcode revision.
Comment	This field is not selectable. There is no help text associated with it.

Field Name	Total Memory
Default Value	Display the installed memory size.
Comment	This field is not selectable. There is no help text associated with it.

Field Name	Memory Slot 1
Default Value	Display the installed memory size of slot 1.
Comment	This field is not selectable. There is no help text associated with it

Field Name	Memory Slot 2
Default Value	Display the installed memory size of slot 2.
Comment	This field is not selectable. There is no help text associated with it

Field Name	Memory Frequency
Default Value	Display the installed memory Frequency
Comment	This field is not selectable. There is no help text associated with it.

Field Name	Serial ATA Port 4
Value	Display the installed SATA device model/size of port 4.
Comment	This field is not selectable. There is no help text associated with it.

Field Name	Serial ATA Port 5
Value	Display the installed SATA device model/size of port 5.
Comment	This field is not selectable. There is no help text associated with it.

Field Name	Serial ATA Port 6
Value	Display the installed SATA device model/size of port 6.
Comment	This field is not selectable. There is no help text associated with it.

Field Name	Serial ATA Port 7
Value	Display the installed SATA device model/size of port 7.
Comment	This field is not selectable. There is no help text associated with it.

Field Name	System Date
Default Value	[Www mm/dd/yyyy]
Possible Value	Www : Mon/Tue/Wed/Thu/Fri/Sat/Sun mm : 1-12 dd : 1-31 yyyy : 1900-9999
Help	Set the Date. Use Tab to switch between Date elements. Default Rangers: Year : 1900-9999 Months : 1-12 Days : Dependent on month Range of Years may vary.

Field Name	System Time
Default Value	[hh :mm :ss]
Possible Value	hh : 0-23 mm : 0-59 ss : 0-59
Help	Set the Time. Use Tab to switch between Time elements.

3.4 Advance Page

This section facilitates configuring advanced BIOS options for your system.

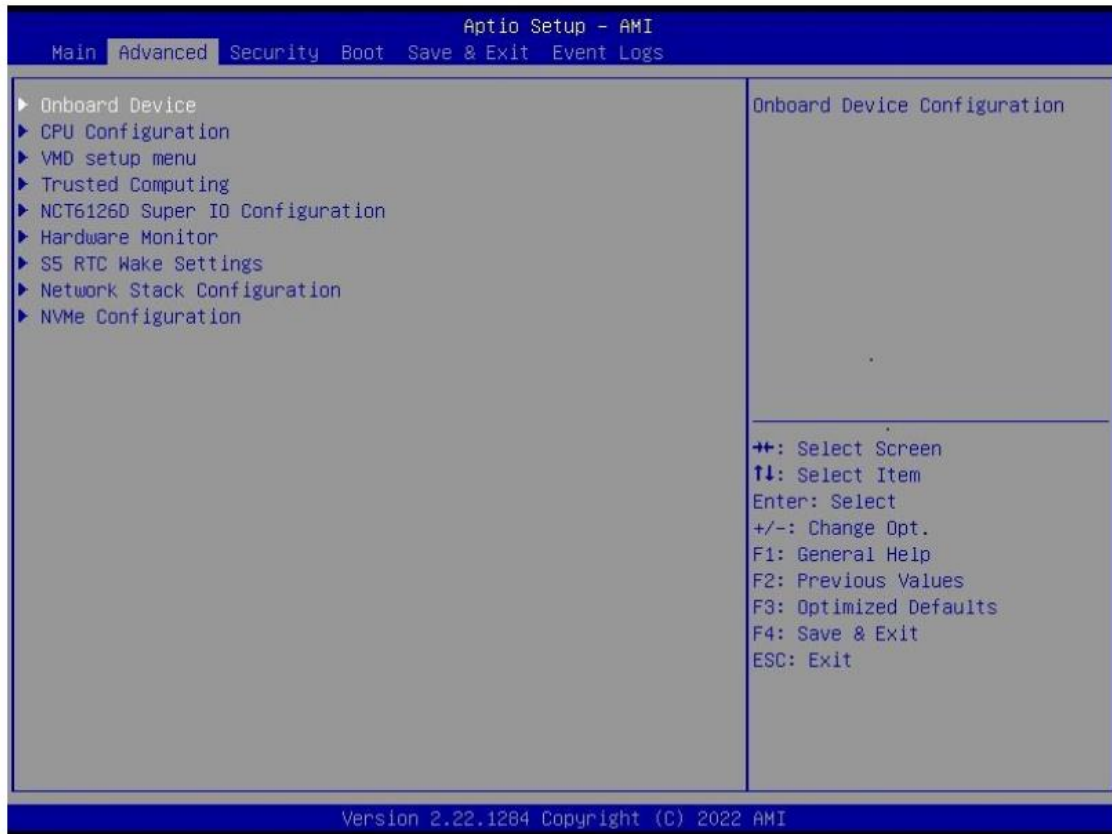

Field Name	Onboard Device
Help	Onboard Device Configuration
Comment	Press Enter when selected to go into the associated Sub-Menu.

Field Name	CPU Configuration
Help	CPU Configuration Parameters
Comment	Press Enter when selected to go into the associated Sub-Menu.

Field Name	VMD setup menu
Help	VMD setup menu
Comment	Press Enter when selected to go into the associated Sub-Menu.

Field Name	Trusted Computing
Help	Trusted Computing Settings
Comment	Press Enter when selected to go into the associated Sub-Menu.

Field Name	Super IO Configuration
Help	System Super IO Chip Parameters.
Comment	Press Enter when selected to go into the associated Sub-Menu.

Field Name	HW Monitor
Help	Monitor hardware status
Comment	Press Enter when selected to go into the associated Sub-Menu.

Field Name	Network Stack Configuration
Help	Network Stack Settings.
Comment	Press Enter when selected to go into the associated Sub-Menu.

Field Name	NVMe Configuration
Help	NVMe Device Options Settings
Comment	Press Enter when selected to go into the associated Sub-Menu.

3.4.1 Onboard Device

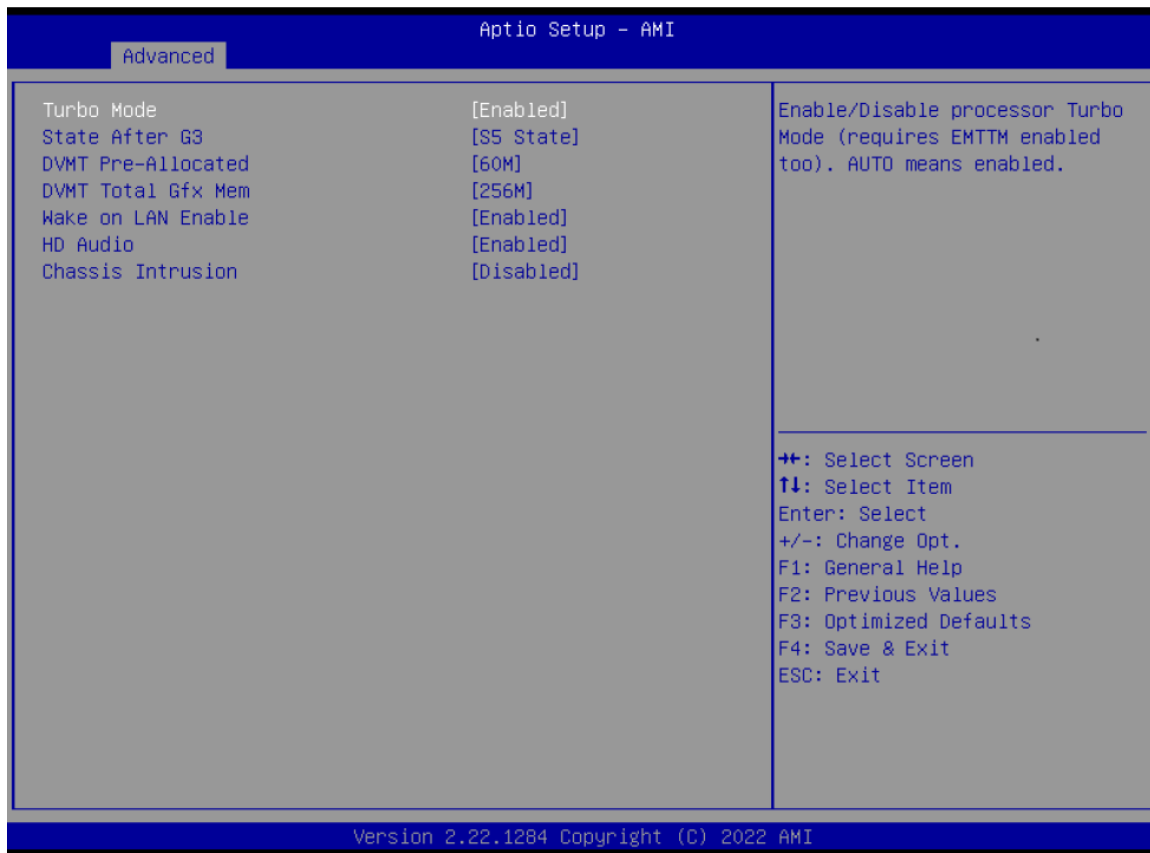

Field Name	DVT Total Gfx Mem
Default Value	[256M]
Possible Value	128M 256M MAX
Help	Select DVMT5.0 Total Graphic Memory size used by the Internal Graphics Device.

Field Name	Wake on LAN Enable
Default Value	[Enabled]
Possible Value	Enabled Disabled
Help	Enable/Disable integrated LAN to wake the system.

Field Name	HD Audio
Default Value	[Enabled]
Possible Value	Enabled Disabled
Help	Control Detection of the HD-Audio device. Disabled = HDA will be unconditionally disabled Enabled = HDA will be unconditionally enabled.

Field Name	Chassis Intrusion
Default Value	[Disabled]
Possible Value	Disabled Enabled Reset
Help	Configure Chassis Intrusion.

3.4.2 CPU Configuration

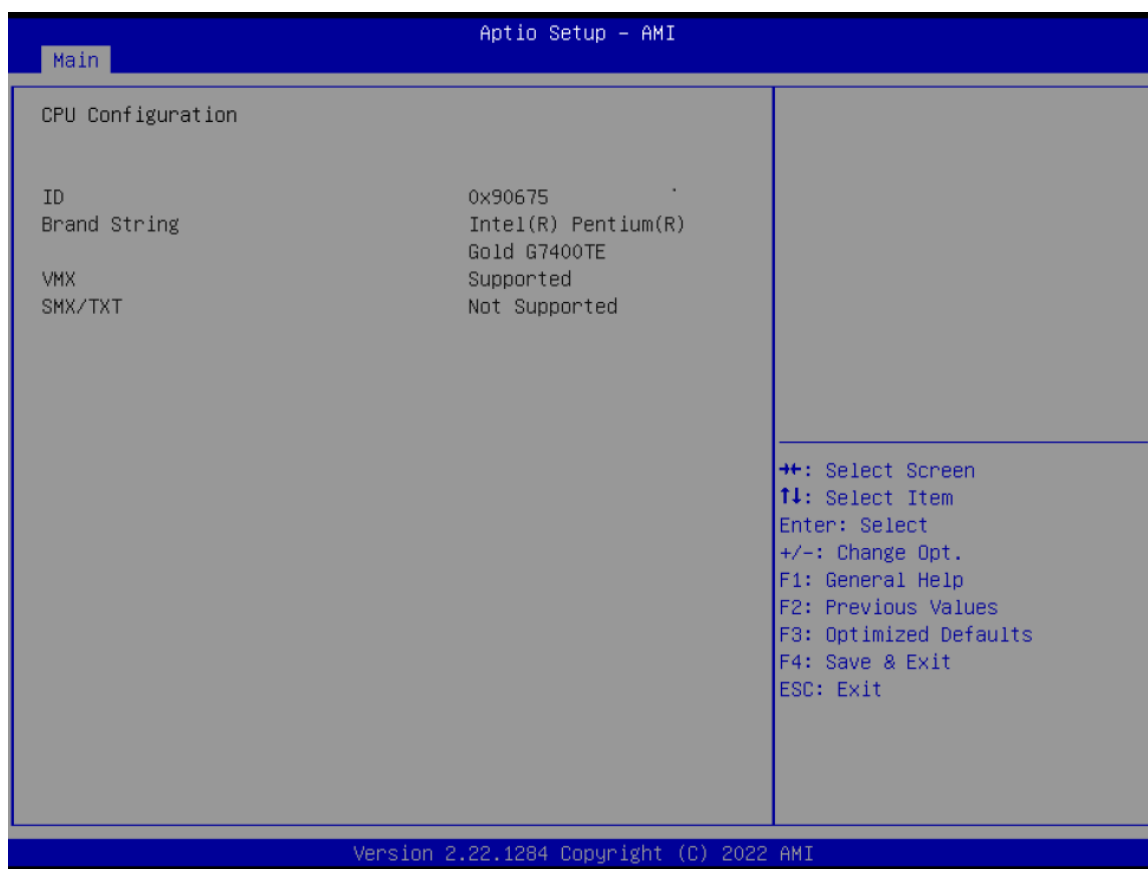

Field Name	ID
Default Value	Displays CPU Signature
Comment	This field is not selectable. There is no help text associated with it.

Field Name	Brand String
Default Value	Displays the CPU brand string
Comment	This field is not selectable. There is no help text associated with it.

Field Name	VXM
Default Value	L3 Cache Size
Comment	This field is not selectable. There is no help text associated with it.

Field Name	SMX/TXT
Default Value	SMX/TXT Supported or Not
Comment	This field is not selectable. There is no help text associated with it.

3.4.3 VMD setup menu

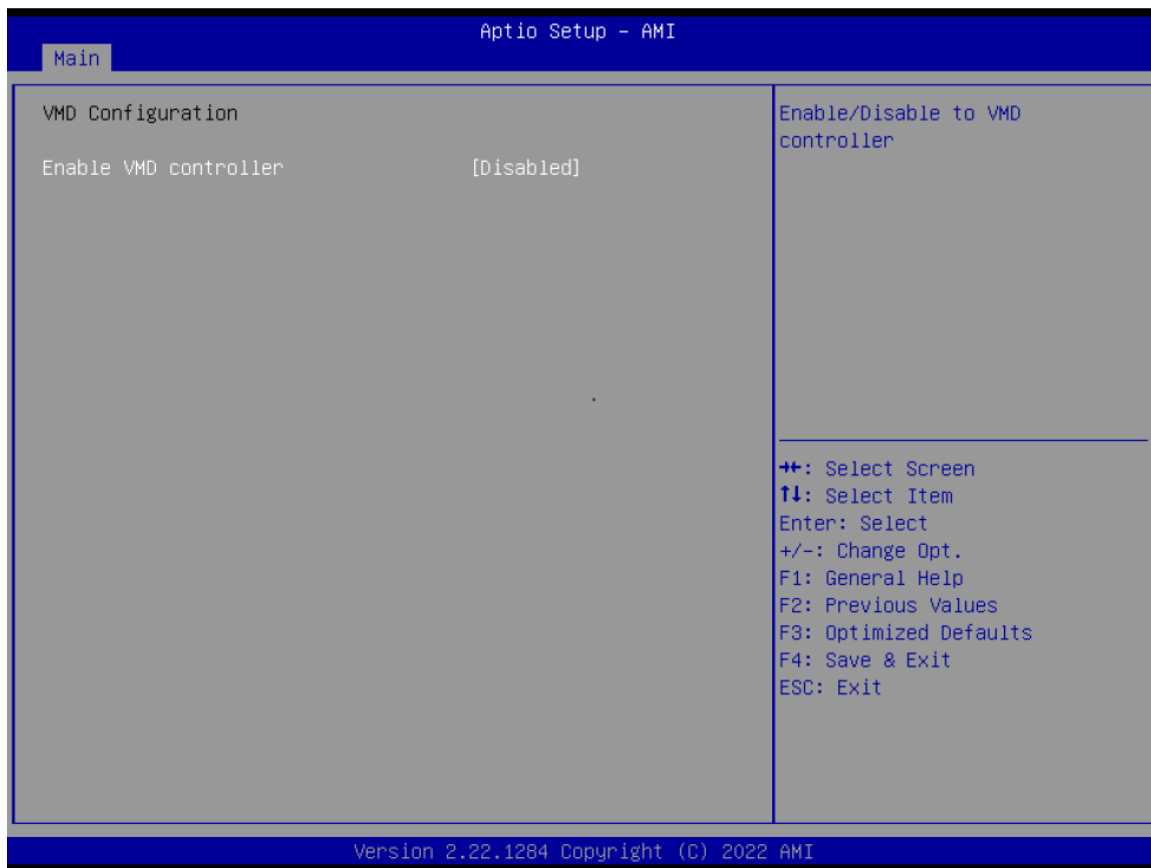

Field Name	VMD Configuration
Default Value	VMD Configuration.
Comment	This field is not selectable. There is no help text associated with it.

Field Name	Enable VMD controller
Default Value	[Disabled]
Possible Value	Enabled Disabled
Help	Enable/Disable to VMD controller.

3.4.4 Trusted Computing



Field Name	FW Version
Default Value	TPM module version
Comment	This field is not selectable. There is no help text associated with it.

Field Name	Vender
Default Value	TPM module version
Comment	This field is not selectable. There is no help text associated with it.

Field Name	Security Device Support
Default Value	[Enable]
Possible Value	Enable Disable
Help	Enables or Disables BIOS support for security device. O.S. will not show Security Device. TCG EFI protocol and INT1A interface will not be available.

Field Name	Pending operation
Default Value	[None]
Possible Value	None TPM Clear
Help	Schedule an Operation for the Security Device. NOTE: Your Computer will reboot during restart in order to change State of Security Device.

3.4.5 Super IO Configuration



Field Name	Serial Port 1 Configuration
Help	Set Parameters of Serial Port 1 (COMA)
Comment	Press Enter when selected to go into the associated Sub-Menu.

Field Name	Serial Port 2 Configuration
Help	Set Parameters of Serial Port 2 (COMB)

Comment	Press Enter when selected to go into the associated Sub-Menu.
---------	---

3.4.6 Serial Port 1 Configuration

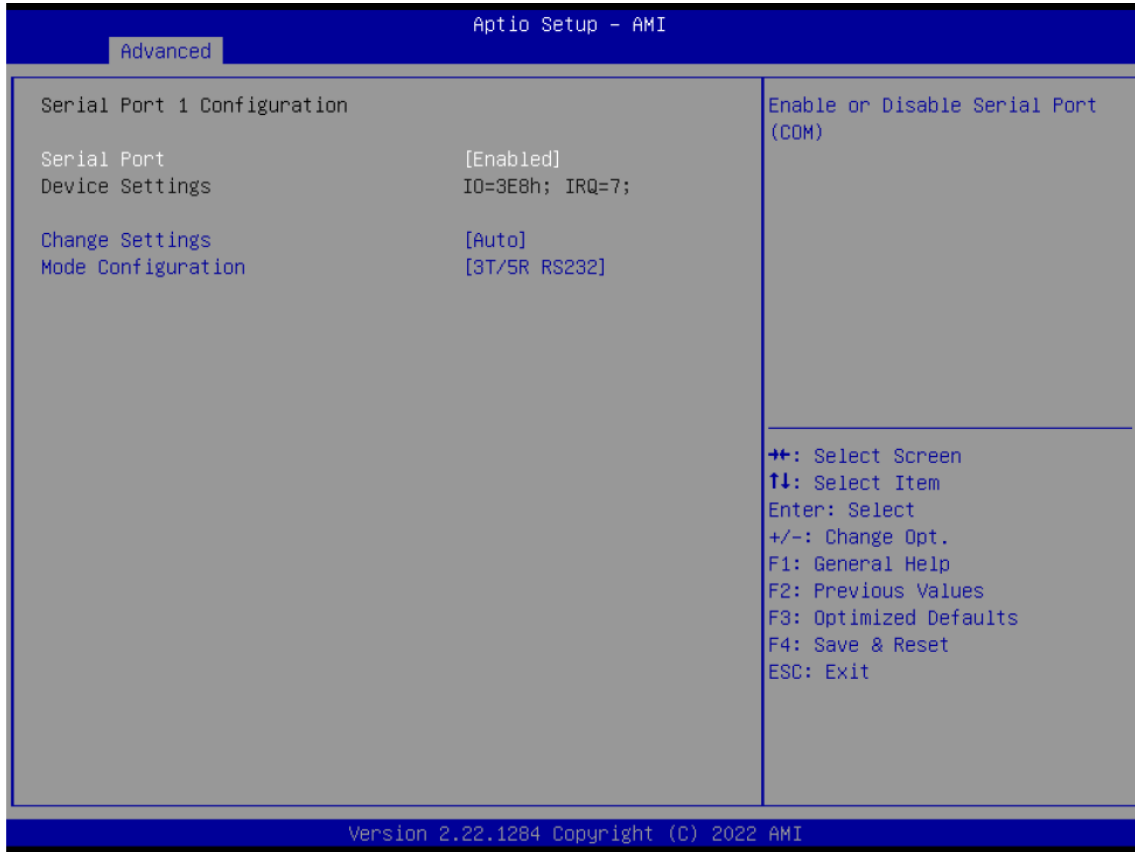

Field Name	Serial Port
Default Value	[Enabled]
Possible Value	Disabled Enabled
Help	Enable or Disable Serial Port(COM)

Field Name	Device Settings
Default Value	Device Super IO COM1 Address and IRQ.
Comment	This field is not selectable. There is no help text associated with it.

Field Name	Change Settings
Default Value	[AUTO]
Possible Value	Auto IO=3E8h; IRQ=7; IO=3E8h; IRQ=3,4,5,6,7,9,10,11,12; IO=2E8h; IRQ=3,4,5,6,7,9,10,11,12; IO=220h; IRQ=3,4,5,6,7,9,10,11,12; IO=228h; IRQ=3,4,5,6,7,9,10,11,12;
Help	Select an optimal settings for Super IO Device

Field Name	Mode Configuration
Default Value	[3T/5R RS232]
Possible Value	1T/1R RS422 3T/5R RS232 1T/1R RS485 TX ENABLE Low Active 1T/1R RS422 with termination resistor 1T/1R RS485 with termination resistor TX ENABLE Low Active Disabled
Help	Configure serial port as RS232/RS422/RS485.

3.4.7 Serial Port 2 Configuration



Field Name	Serial Port
Default Value	[Enabled]
Possible Value	Disabled Enabled
Help	Enable or Disable Serial Port(COM)

Field Name	Device Settings
Default Value	Device Super IO COM2 Address and IRQ.
Comment	This field is not selectable. There is no help text associated with it.

Field Name	Change Settings
Default Value	[AUTO]
Possible Value	Auto IO=2E8h; IRQ=7; IO=3E8h; IRQ=3,4,5,6,7,9,10,11,12; IO=2E8h; IRQ=3,4,5,6,7,9,10,11,12; IO=220h; IRQ=3,4,5,6,7,9,10,11,12; IO=228h; IRQ=3,4,5,6,7,9,10,11,12;
Help	Select an optimal settings for Super IO Device

3.4.8 Hardware Monitor

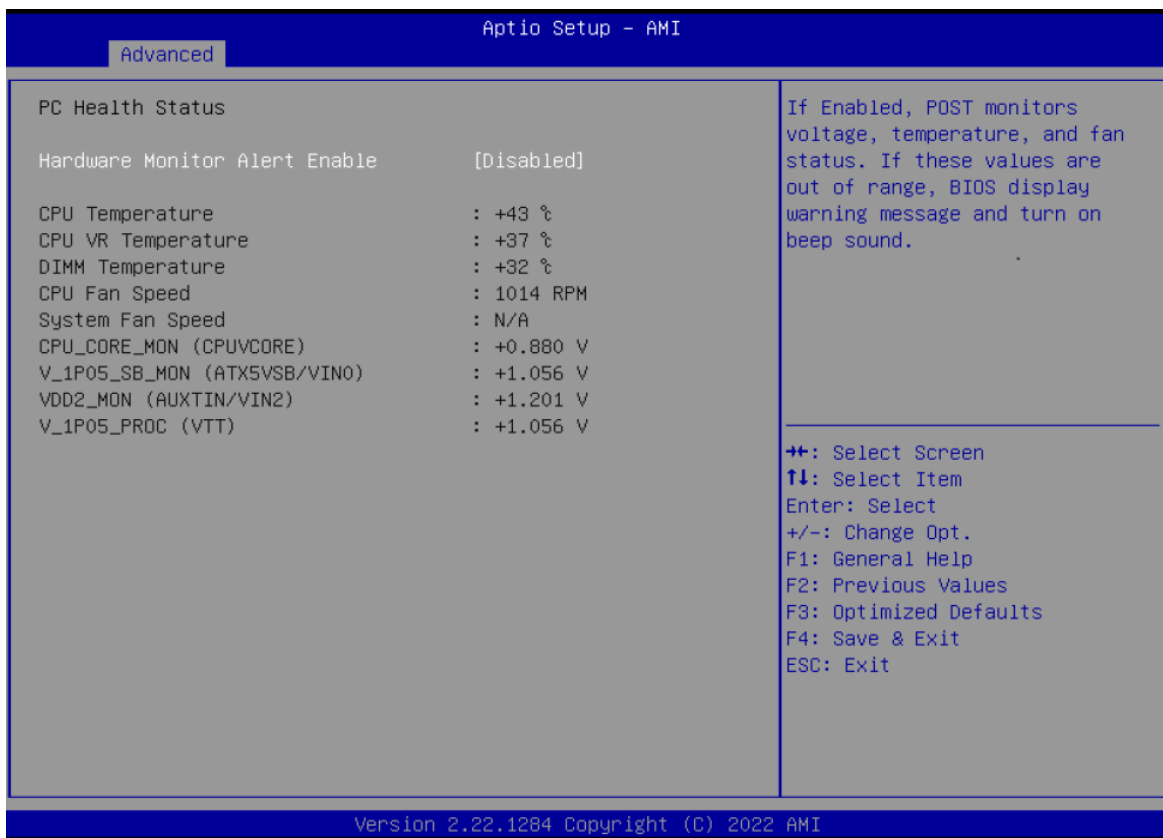

Type	Range
CPU Temperature	-20 ~ (By Processor Tjmax)°C
CPU VR Temperature	-20 ~ 120°C
CPU Fan Speed	There are many kinds of the fan could be installed into the system, so we could only set 0 RPM for the failed fan speed, and there is also no high RPM limitation.
Front Fan Speed	
CPU Vcore	0~1.72V
V_1P05_SB	0.9975~1.1025V
VDD2	1.045~1.155V
V_1P05_PROC	0.9975~1.1025V

Field Name	Hardware Monitor Alert Enable
Default Value	[Disabled]
Possible Value	Enabled Disabled
Help	If Enabled, POST monitors voltage, temperature, and fan status. If these values are out of range, BIOS display warning message and turn on beep sound.

Field Name	System Fan Enable (Suppressed if Hardware Monitor Alert is Disabled)
Default Value	[Disabled]
Possible Value	Enabled Disabled
Help	If Enabled, POST monitors voltage, temperature, and fan status. If these values are out of range, BIOS display warning message and turn on beep sound.

3.4.9 S5 RTC Wake Settings



Field Name	Wake system from S5
Default Value	[Disabled]
Possible Value	Disabled Fixed Time
Help	Enable or disable System wake on alarm event, Select FixedTime, system will wake on the hr::min::sec specified.

Field Name	Wake up hour(Show when Wake system from S5 set to Fixed Time)
Default Value	0
Possible Value	0-23
Help	Select 0-23 For example enter 3 for 3am and 15 for 3pm

Field Name	Wake up hour(Show when Wake system from S5 set to Fixed Time)
Default Value	0
Possible Value	0-59
Help	Select 0-59 For Minute

Field Name	Wake up hour(Show when Wake system from S5 set to Fixed Time)
Default Value	0
Possible Value	0-59
Help	Select 0-59 For Second

3.4.10 Network Stack Configuration



Field Name	Network stack
Default Value	[Disabled]
Possible Value	Disabled

	Enabled
Help	Enable/Disable UEFI Network stack.

Field Name	Ipv4 PXE Support (Available when Network stack Enabled)
Default Value	[Enabled]
Possible Value	Disabled Enabled
Help	Enable/Disable Ipv4 PXE Boot Support. If disabled IPV4 PXE boot support will not be available.

Field Name	Ipv6 PXE Support (Available when Network stack Enabled)
Default Value	[Enabled]
Possible Value	Disabled Enabled
Help	Enable/Disable Ipv6 PXE Boot Support. If disabled IPV6 PXE boot support will not be available.

3.4.11 NVMe Configuration

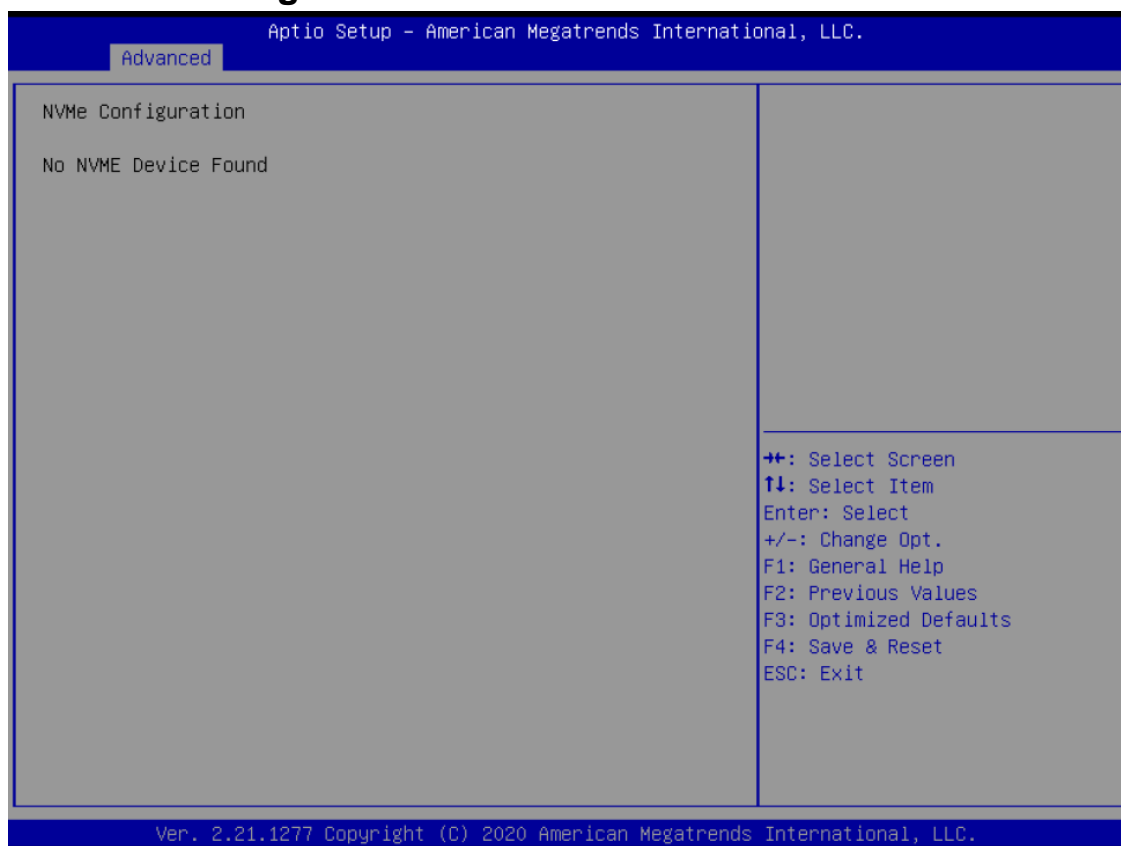

Field Name	(Device)
Comment	Press Enter when selected to go into the associated Sub-Menu.

3.5 Security Page

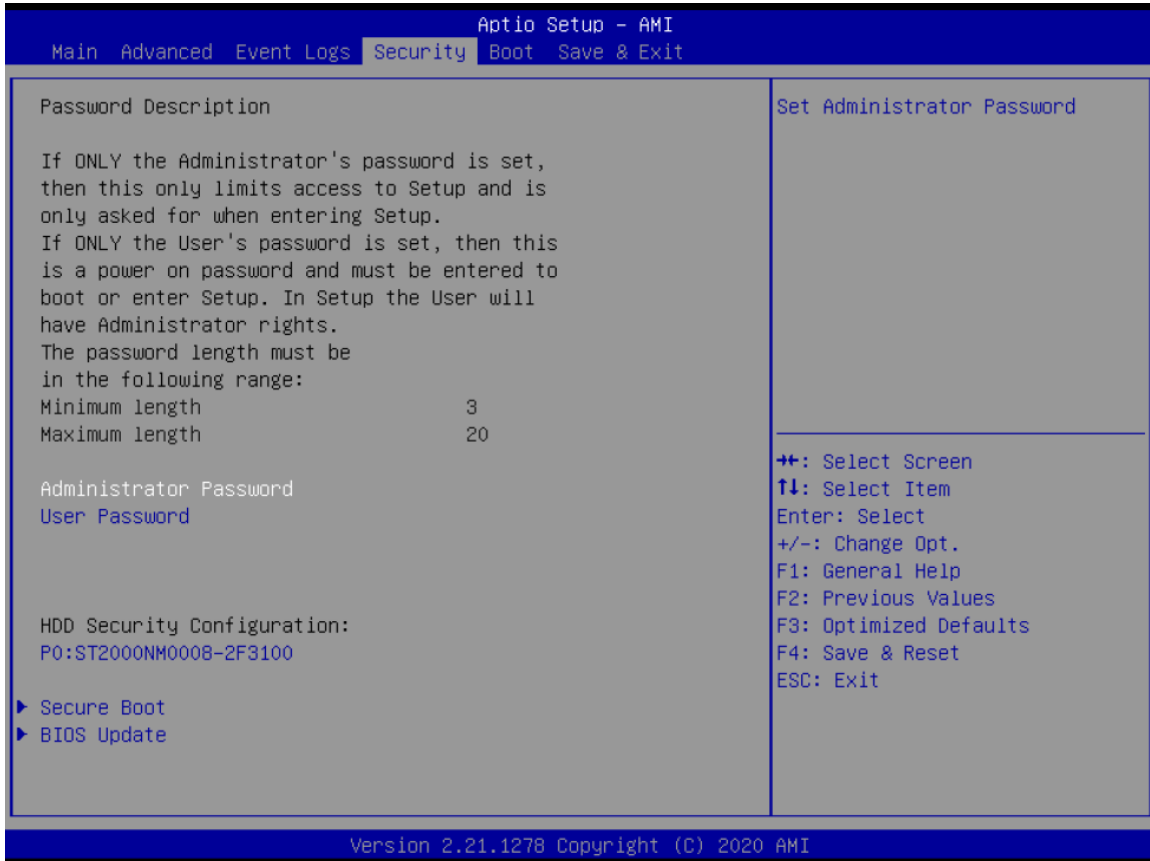

Field Name	Administrator Password
Help	Set Administrator Password

Field Name	User Password
Help	Set User Password.

Field Name	HDD Security drive
Help	HDD Security Configuration for selected drive
Comment	Press Enter when selected to go into the associated Sub-Menu.

Field Name	Secure Boot
Help	Set User Password.

Comment	Press Enter when selected to go into the associated Sub-Menu.
---------	---

Field Name	BIOS Update
Help	BIOS Update support
Comment	Press Enter when selected to go into the associated Sub-Menu.

3.5.1 HDD Security

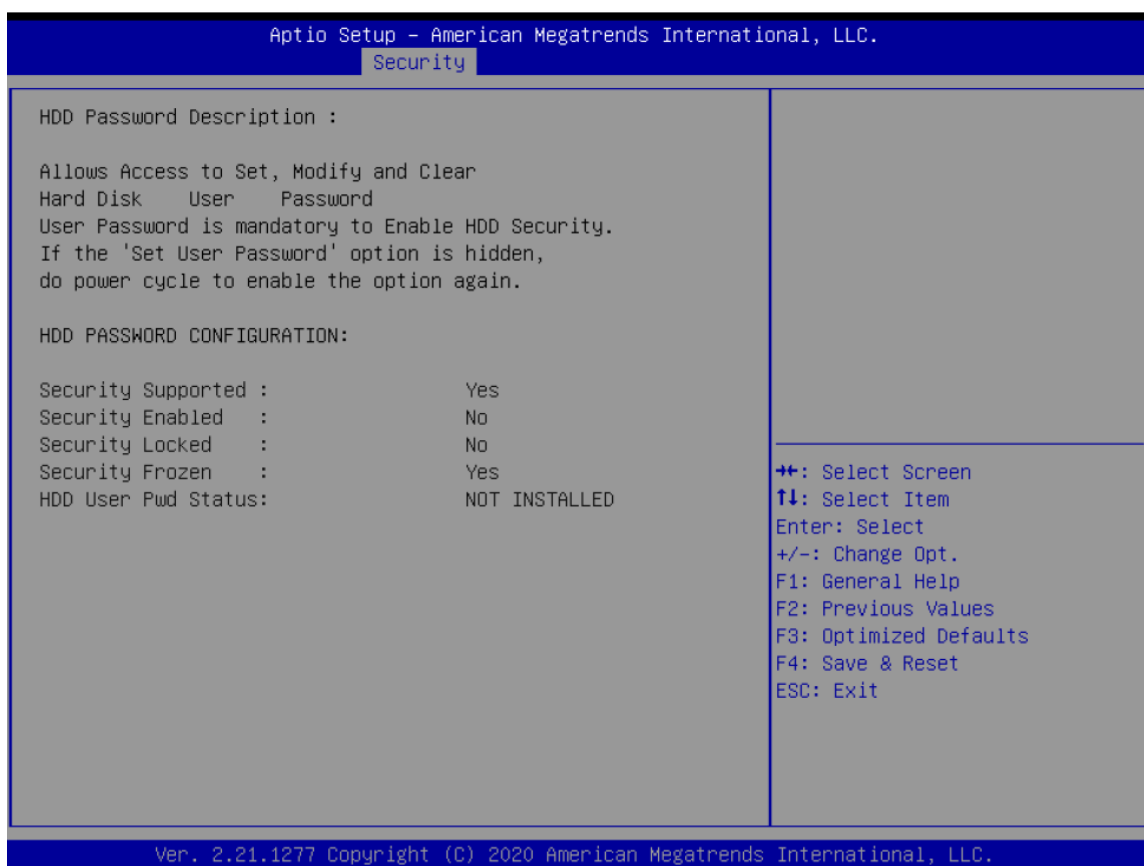

Field Name	Set User Password
Help	Set HDD User Password. *** Advisable to Power Cycle System after Setting Hard Disk Passwords ***.Discard or Save changes option in setup does not have any impact on HDD when password is set or removed. If the 'Set HDD User Password' option is hidden, do power cycle to enable the option again

3.5.2 Secure Boot



Field Name	Secure Boot
Default Value	[Enabled]
Possible Value	Enabled Disabled
Help	Secure Boot feature is Active if Secure Boot is Enabled, Platform Key(PK) is enrolled and the System is in User mode. The mode change requires platform reset

Field Name	Secure Boot Mode
Default Value	[Standard]
Possible Value	Standard Custom
Help	Secure Boot mode options: Standard or Custom. In Custom mode,

	Secure Boot Policy variables can be configured by a physically present user without full authentication
--	---

Field Name	Restore Factory Keys
Help	Force System to User Mode. Install factory default Secure Boot key databases

Field Name	Reset to Setup Mode
Help	Delete all Secure Boot key databases from NVRAM

Field Name	Key Management
Help	Enables expert users to modify Secure Boot Policy variables without full authentication
Comment	Enables expert users to modify Secure Boot Policy variables without full authentication

3.5.3 Key Management

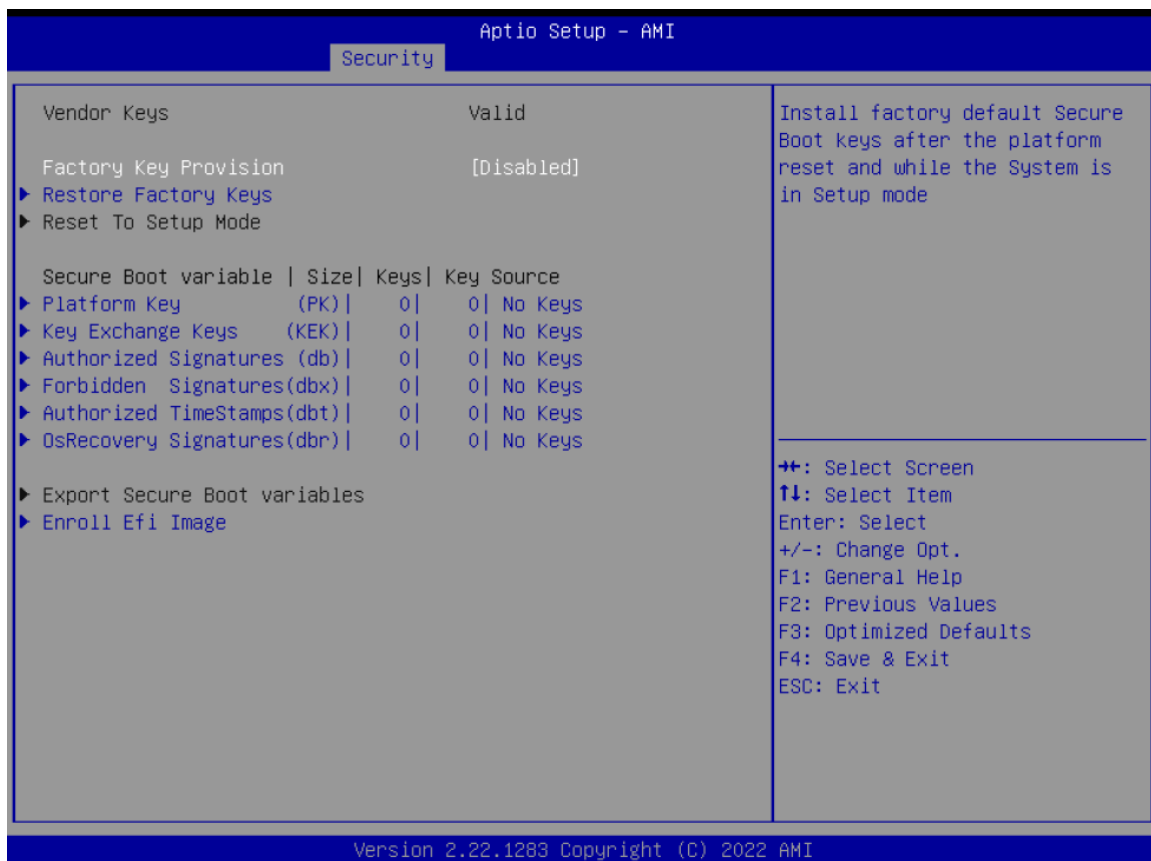

Field Name	Factory Key Provision
Default Value	[Disabled]
Possible Value	Enabled Disabled
Help	Install factory default Secure Boot keys after the platform reset and while the System is in Setup mode

Field Name	Restore Factory Keys
Help	Force System to User Mode. Install factory default Secure Boot key databases

Field Name	Reset to Setup Mode
Help	Delete all Secure Boot key databases from NVRAM

Field Name	Platform Key (PK)
Default Value	Size:0, Keys:0, Key source: No Keys
Help	Enroll Factory Defaults or load certificates from a file: 1.Public Key Certificate: a)EFI_SIGNATURE_LIST b)EFI_CERT_X509 (DER) c)EFI_CERT_RSA2048 (bin) d)EFI_CERT_SHAXXX 2.Authenticated UEFI Variable 3.EFI PE/COFF Image(SHA256) Key Source: Factory,External,Mixed
Comment	Press Enter when selected to go into the associated Sub-Menu "Key Management".

Field Name	Key Exchange Keys
Default Value	Size:0, Keys:0, Key source: No Keys
Help	Enroll Factory Defaults or load certificates from a file: 1.Public Key Certificate: a)EFI_SIGNATURE_LIST b)EFI_CERT_X509 (DER) c)EFI_CERT_RSA2048 (bin) d)EFI_CERT_SHAXXX 2.Authenticated UEFI Variable 3.EFI PE/COFF Image(SHA256) Key Source: Factory,External,Mixed
Comment	Press Enter when selected to go into the associated Sub-Menu.

Field Name	Authorized Signatures
Default Value	Size:0, Keys:0, Key source: No Keys
Help	Enroll Factory Defaults or load certificates from a file: 1.Public Key Certificate: a)EFI_SIGNATURE_LIST b)EFI_CERT_X509 (DER) c)EFI_CERT_RSA2048 (bin) d)EFI_CERT_SHAXXX 2.Authenticated UEFI Variable 3.EFI PE/COFF Image(SHA256) Key Source: Factory,External,Mixed
Comment	Press Enter when selected to go into the associated Sub-Menu.

Field Name	Forbidden Signatures
Default Value	Size:0, Keys:0, Key source: No Keys
Help	Enroll Factory Defaults or load certificates from a file: 1.Public Key Certificate: a)EFI_SIGNATURE_LIST b)EFI_CERT_X509 (DER) c)EFI_CERT_RSA2048 (bin) d)EFI_CERT_SHAXXX 2.Authenticated UEFI Variable 3.EFI PE/COFF Image(SHA256) Key Source: Factory,External,Mixed
Comment	Press Enter when selected to go into the associated Sub-Menu.

Field Name	Authorized Time Stamps
Default Value	Size:0, Keys:0, Key source: No Keys
Help	Enroll Factory Defaults or load certificates from a file: 1.Public Key Certificate: a)EFI_SIGNATURE_LIST b)EFI_CERT_X509 (DER) c)EFI_CERT_RSA2048 (bin) d)EFI_CERT_SHAXXX 2.Authenticated UEFI Variable 3.EFI PE/COFF Image(SHA256) Key Source: Factory,External,Mixed
Comment	Press Enter when selected to go into the associated Sub-Menu.

Field Name	OsRecovery Signatures
Default Value	Size:0, Keys:0, Key source: No Keys
Help	Enroll Factory Defaults or load certificates from a file: 1.Public Key Certificate: a)EFI_SIGNATURE_LIST b)EFI_CERT_X509 (DER) c)EFI_CERT_RSA2048 (bin) d)EFI_CERT_SHAXXX 2.Authenticated UEFI Variable 3.EFI PE/COFF Image(SHA256) Key Source: Factory,External,Mixed
Comment	Press Enter when selected to go into the associated Sub-Menu.

Field Name	Export Secure Boot variables
Help	Copy NVRAM content of Secure Boot variables to files in a root folder on a file system device

Field Name	Enroll Efi Image
Help	Allow the image to run in Secure Boot mode. Enroll SHA256 Hash certificate of a PE image into Authorized Signature Database (db)

3.6 Boot Page

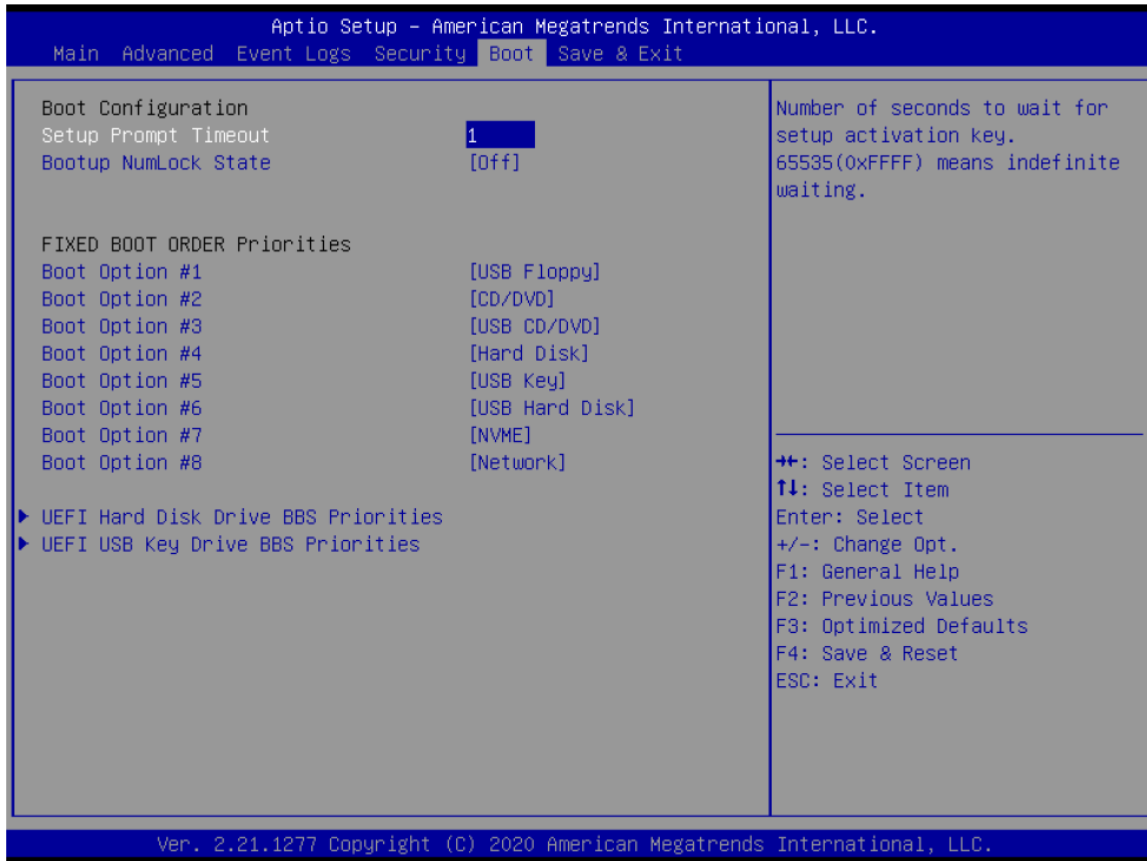

Field Name	Setup Prompt Timeout
Default Value	1
Possible Value	1~65535
Comment	Number of seconds to wait for setup activation key. 65535(0xFFFF) means indefinite waiting.

Field Name	Bootup NumLock State
Default Value	[Off]
Possible Value	On Off
Comment	Select the keyboard NumLock state

Field Name	Boot Option #1
Default Value	[USB Floppy]
Possible Value	USB Floppy, CD/DVD, USB CD/DVD, Hard Disk , USB Key, USB Hard Disk , NVME, Network, Disabled
Comment	Sets the system boot order

Field Name	Boot Option #2
Default Value	[CD/DVD]
Possible Value	USB Floppy, CD/DVD, USB CD/DVD, Hard Disk , USB Key, USB Hard Disk , NVME, Network, Disabled
Comment	Sets the system boot order

Field Name	Boot Option #3
Default Value	[USB CD/DVD]
Possible Value	USB Floppy, CD/DVD, USB CD/DVD, Hard Disk , USB Key, USB Hard Disk , NVME, Network, Disabled
Comment	Sets the system boot order

Field Name	Boot Option #4
Default Value	[Hard Disk]
Possible Value	USB Floppy, CD/DVD, USB CD/DVD, Hard Disk , USB Key, USB Hard Disk , NVME, Network, Disabled
Comment	Sets the system boot order

Field Name	Boot Option #5
Default Value	[USB Key]
Possible Value	USB Floppy, CD/DVD, USB CD/DVD, Hard Disk , USB Key, USB Hard Disk , NVME, Network, Disabled
Comment	Sets the system boot order

Field Name	Boot Option #6
Default Value	[USB Hard Disk]
Possible Value	USB Floppy, CD/DVD, USB CD/DVD, Hard Disk , USB Key, USB Hard Disk , NVME, Network, Disabled
Comment	Sets the system boot order

Field Name	Boot Option #7
Default Value	[NVME]
Possible Value	USB Floppy, CD/DVD, USB CD/DVD, Hard Disk , USB Key, USB Hard Disk , NVME, Network, Disabled
Comment	Sets the system boot order

Field Name	Boot Option #8
Default Value	[Network]
Possible Value	USB Floppy, CD/DVD, USB CD/DVD, Hard Disk , USB Key, USB Hard Disk , NVME, Network, Disabled
Comment	Sets the system boot order

Field Name	(UEFI) USB Floppy Drive BBS Priorities
Help	Specifies the Boot Device Priority sequence from available USB Floppy Drives.
Comment	Press Enter when selected to go into the associated Sub-Menu.

Field Name	(UEFI) CDROM/DVD ROM Drive BBS Priorities
Help	Specifies the Boot Device Priority sequence from available USB CDROM/DVD Drives.
Comment	Press Enter when selected to go into the associated Sub-Menu.

Field Name	(UEFI) USB CDROM/DVD ROM Drive BBS Priorities
Help	Specifies the Boot Device Priority sequence from available USB CDROM/DVD Drives.
Comment	Press Enter when selected to go into the associated Sub-Menu.

Field Name	(UEFI) Hard Disk Drive BBS Priorities
Help	Specifies the Boot Device Priority sequence from available Hard Disk Drives.
Comment	Press Enter when selected to go into the associated Sub-Menu.

Field Name	(UEFI) USB KEY Drive BBS Priorities
Help	Specifies the Boot Device Priority sequence from available Hard Disk Drives.

Comment	Press Enter when selected to go into the associated Sub-Menu.
Field Name	(UEFI) USB Hard Disk Drive BBS Priorities
Help	Specifies the Boot Device Priority sequence from available Hard Disk Drives.
Comment	Press Enter when selected to go into the associated Sub-Menu.

Field Name	(UEFI) NETWORK Drive BBS Priorities
Help	Specifies the Boot Device Priority sequence from available Hard Disk Drives.
Comment	Press Enter when selected to go into the associated Sub-Menu.

3.6.1 (List Boot Device Type) Drive BBS Priorities

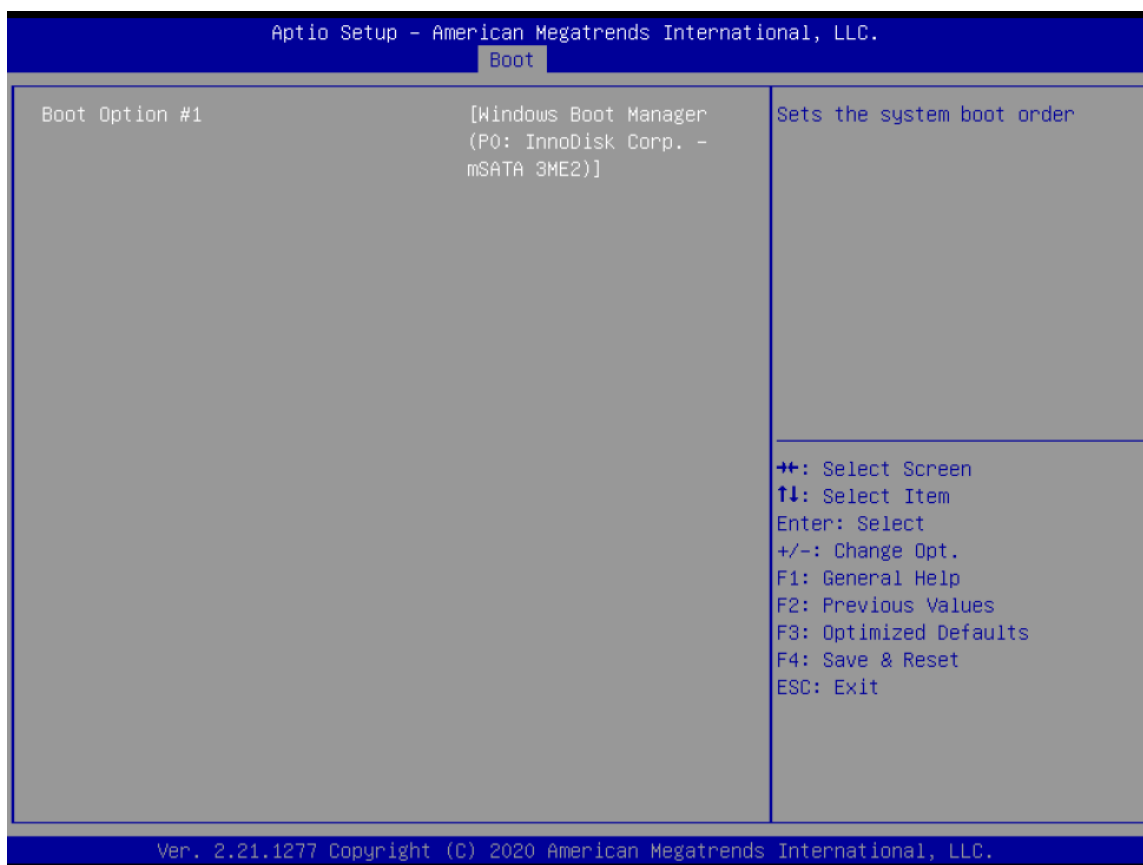

Field Name	Boot Option #1
Default Value	
Possible Value	Boot Device Name 1 of this type

Help	Sets the system boot order
------	----------------------------

3.7 Save & Exit Page



Field Name	Discard Changes and Exit
Help	Exit system setup without saving any changes.

Field Name	Save Changes and Reset
Help	Reset the system after saving the changes.

Field Name	Restore Defaults
Help	Restore/Load Default values for all the setup options.

3.8 Event Logs

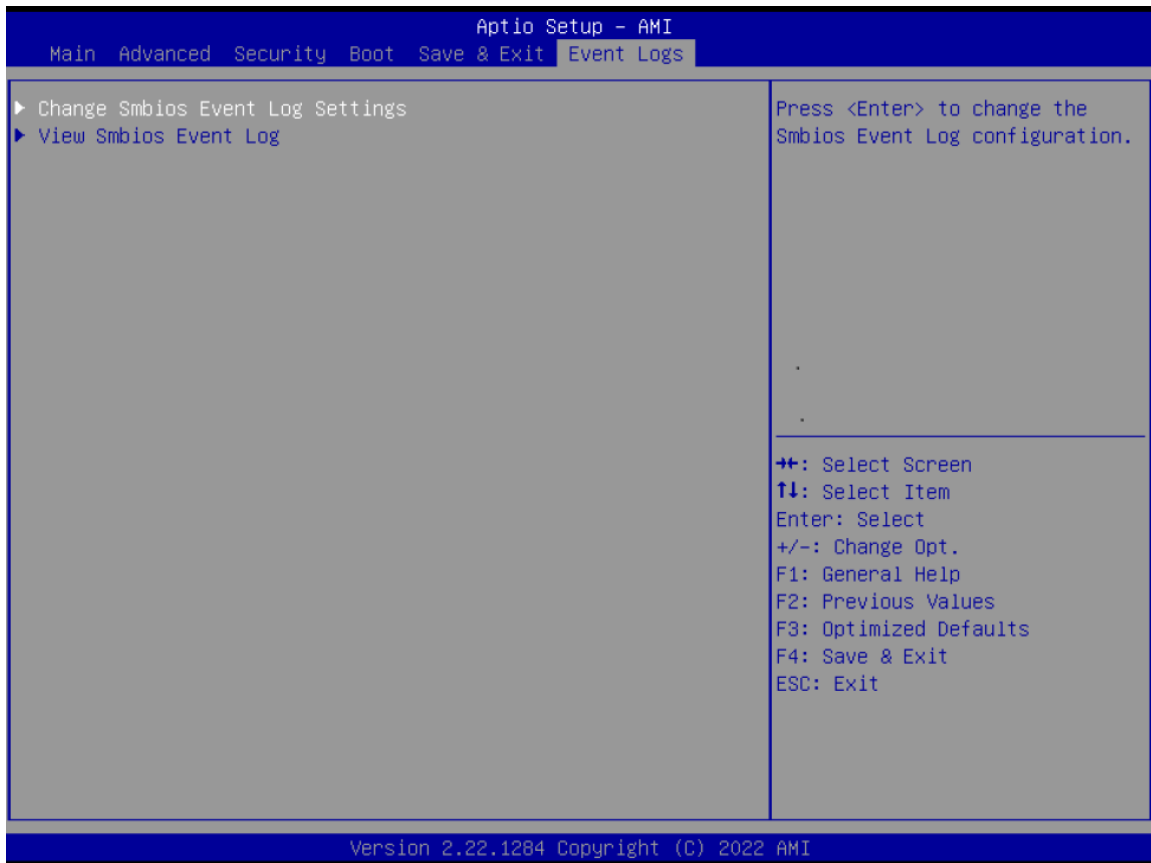

Field Name	Change Smbios Event Log Settings
Help	Press <Enter> to change the Smbios Event Log configuration.
Comment	Press Enter when selected to go into the associated Sub-Menu.

Field Name	View Smbios Event Log
Help	Press <Enter> to change the Smbios Event Log configuration.
Comment	Press Enter when selected to go into the associated Sub-Menu.

3.8.1 Change Smbios Event Log Setting



Field Name	Smbios Event Log
Default Value	[Enabled]
Possible Value	Enabled Disabled
Help	Change this to enable or disable all feature of Smbios Event Logging during boot.

Field Name	Erase Event Log
Default Value	[No]
Possible Value	No / Yes, Next reset / Yes, Every reset
Help	Choose options for erasing Smbios Event Log. Erasing is done prior to any logging activation during reset.

Field Name	Whea Log is Full
Default Value	[Do Nothing]
Possible Value	Do Nothing Erase Immediately
Help	Choose options for reactions to a full Smbios Event Log.

3.8.2 View Smbios Event Log

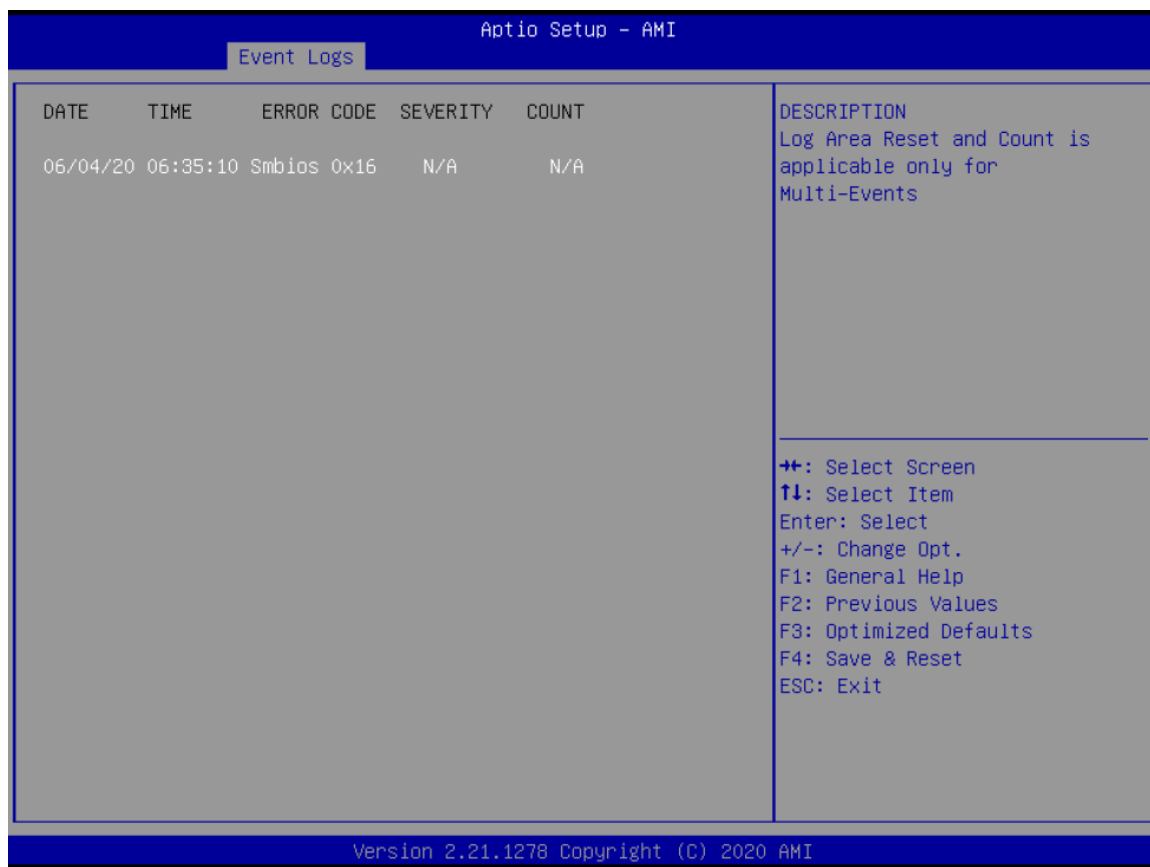

Field Name	DATE / TIME / ERROR CODE / SEVERITY / COUNT
Default Value	MM/DD/YY HH:MM:SS Smbios 0x16 N/A N/A
Possible Value	By Events.
Help	By Events.