

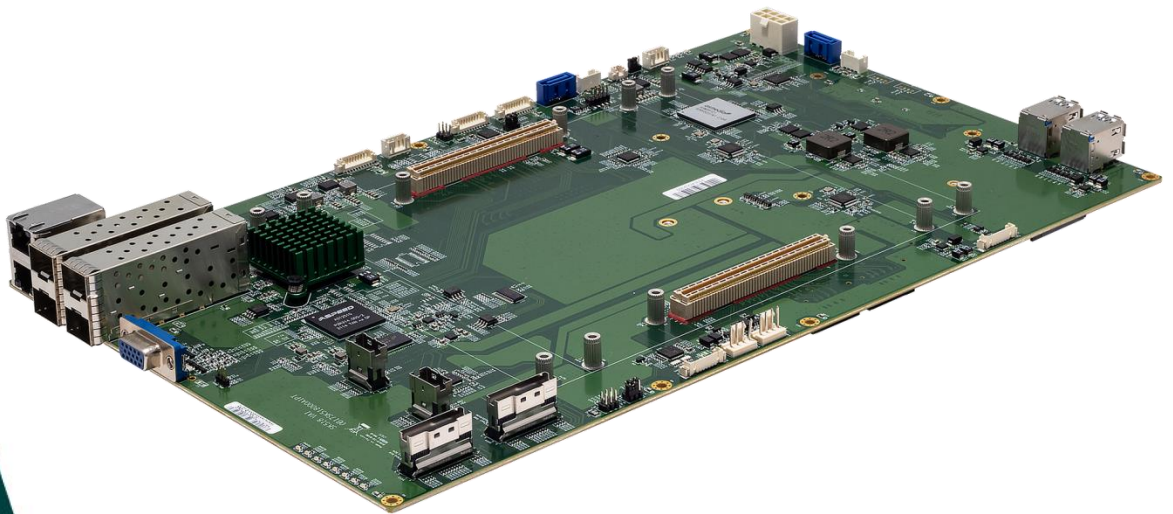

SK518

**COH-HPC Server Size D Carrier Board with PCIe/104,
Slim-SAS Express Expansions Extreme temperature
-40°C to 85°C**



User's Manual

Revision Date: Jan 18 2024

Safety Information

Electrical safety

- To prevent electrical shock hazard, disconnect the power cable from the electrical outlet before relocating the system.
- When adding or removing devices to or from the system, ensure that the power cables for the devices are unplugged before the signal cables are connected. If possible, disconnect all power cables from the existing system before you add a device.
- Before connecting or removing signal cables from the motherboard, ensure that all power cables are unplugged.
- Seek professional assistance before using an adapter or extension cord. These devices could interrupt the grounding circuit.
- Make sure that your power supply is set to the correct voltage in your area.
- If you are not sure about the voltage of the electrical outlet you are using, contact your local power company.
- If the power supply is broken, do not try to fix it by yourself. Contact a qualified service technician or your local distributor.

Operation safety

- Before installing the motherboard and adding devices on it, carefully read all the manuals that came with the package.
- Before using the product, make sure all cables are correctly connected and the power cables are not damaged. If you detect any damage, contact your dealer immediately.
- To avoid short circuits, keep paper clips, screws, and staples away from connectors, slots, sockets and circuitry.
- Avoid dust, humidity, and temperature extremes. Do not place the product in any area where it may become wet.
- Place the product on a stable surface.
- If you encounter any technical problems with the product, contact your local distributor.

Statement

- All rights reserved. No part of this publication may be reproduced in any form or by any means, without prior written permission from the publisher.
- All trademarks are the properties of the respective owners.
- All product specifications are subject to change without prior notice.

Revision History

Revision	Date (yyyy/mm/dd)	Changes
V1.0	2024.1.18	Initial Release

Table of Contents

Safety Information	1
<i>Electrical safety</i>	<i>1</i>
<i>Operation safety</i>	<i>1</i>
<i>Statement</i>	<i>1</i>
Revision History.....	2
Chapter 1: Product Information.....	5
1.1 <i>Key Feature</i>	<i>5</i>
1.2 <i>Board Diagram.....</i>	<i>7</i>
1.3 <i>Dimension.....</i>	<i>8</i>
1.4 <i>Appearance</i>	<i>8</i>
Chapter 2: Jumper and Connector setting	9
2.1 <i>List of Jumpers / Internal Function Connector & Socket</i>	<i>9</i>
2.2 <i>Jumper Setting.....</i>	<i>10</i>
<i>Clear CMOS.....</i>	<i>10</i>
<i>JP1 : COM1 Pin 9 Function Select : 1A</i>	<i>10</i>
<i>JP2 : COM2 Pin 9 Function Select : 1A</i>	<i>10</i>
<i>JP3,JP4 : COM1,2 Function Select : RS232/422/485.....</i>	<i>10</i>
2.3 <i>Connetor Pin Assignment.....</i>	<i>11</i>
<i>DC_IN : DC Input Power Connector (12V/20A).....</i>	<i>11</i>
<i>USB1,2 : 2 Port USB3.0 Type-A Connector</i>	<i>11</i>
<i>10GSFP1,2 : 2 Port 10G SFP+ LAN Connector(Type 1).....</i>	<i>11</i>
<i>LAN1 : 2 Port GbE RJ-45 Connector</i>	<i>12</i>
<i>VGA1 : Slim D-SUB 15 Pin VGA Connector.....</i>	<i>12</i>
<i>CPU Module Connector.....</i>	<i>13</i>
<i>M2P1,2 : M.2 M-key Socket 2280 for SSD.....</i>	<i>13</i>

SK518 User's Manual

Revision Date: Jan 18 2024

<i>MPCIE1: Mini PCIe Socket.....</i>	<i>13</i>
<i>SIM1: 6 pin SIM Socket.....</i>	<i>13</i>
<i>SATA1,2 : 7 Pin DIP SATA Connector.....</i>	<i>14</i>
<i>SATA_PWR1,2 : 4 Pin SATA Power Connector.....</i>	<i>14</i>
<i>SAS1,2 : Slim SAS(x4) PCIe Gen4 Extension Connector.....</i>	<i>14</i>
<i>SAS3,4 : Slim SAS(x8) PCIe Gen4 Extension Connector.....</i>	<i>15</i>
<i>COM1,2 : RS232/422/485 Serial Port Connector</i>	<i>16</i>
<i>DIO1: Digital I/O (3.3V Level) Connector</i>	<i>16</i>
<i>eSPI1 : eSPI Connector</i>	<i>17</i>
<i>JUSB1 : 2 Port USB 2.0 Internal Connector.....</i>	<i>17</i>
<i>FP1 : Front Panel Pin Header(SMD 2.0mm).....</i>	<i>17</i>
<i>FAN1,2 : CPU/System FAN Connector.....</i>	<i>18</i>
<i>SMB1 : SMBus Link(2.0mm Box Header)</i>	<i>18</i>
<i>SMB2 : For Debug Card(2.0mm Box Header).....</i>	<i>18</i>
<i>PCIe104 : PCIe104 Type2 Connector.....</i>	<i>18</i>
<i>BAT1 : CMOS 3.3V Battery Input(1.25mm BOX header).....</i>	<i>19</i>
<i>Function LED.....</i>	<i>19</i>

Chapter 1: Product Information

1.1 Key Feature

System	
CPU	Ampere Altra : Up to 80 Arm-based cores at 175W TDP Intel ICE-Lake HCC : Up to 20 cores at 118W TDP
Memory type	DDR4 R-DIMMs up to 768GB
Chipset	On CPU Module
Storage	SlimSAS/M.2/SATA interface
Watchdog	On CPU module : 1-255 sec. or 1-255 min. software programmable and can be generate system reset.
Expansion	
PCIe/104(Type2)	1(2*PCIe Gen3 x 4/4*PCllexGen3 x 1/2*SATA)
Slim-SAS (Vertical)	2(PCIe Gen4 x 8)
Slim-SAS (Vertical)	2(PCIe Gen4 x 4)
MiniPCIe(Full Size)	1(PCIe Gen3 x 1)
M.2	2(M.2 2280 M-Key)(PCIe Gen4 x 4)
Display	
Chipset	On CPU Module / AST2510
VGA	1
Ethernet	
Chipset	1 x Intel® I210iT 1 x C827
IPMI	AST2500 by request
External I/O	
VGA	1
USB3.0	4
10GbE	4
GbE	2
MXM FAN	1 x MXM FAN
Battery	1 x Battery Header
Internal I/O	
USB2.0	2(Header)

SK518 User's Manual

Revision Date: Jan 18 2024

DIDO	1(4in/4out)
SATAIII	2
SATA Power	2
Serial	2 (RS232)
SM BUS/I2C BUS	1
LPC	1
System Fan	1
CPU Fan	1
Front Panel Control	1
Power Connector	1(2 x 4-pin terminal block)
Mechanical and Environment	
Form Factor	COM-HPC Carrier Server Size D
Power Type	DC-IN 12V
Dimension	350mm x 210mm
Operating Temperature	-40 to 85°C
Storage Temperature	-40 to 85°C
Relative humidity	10% to 90%, non-condensing
Standard Compliance	
Standard Compliance	CE/FCC
OS	
OS	On CPU Module

***All specifications and photos are subject to change without notice.**

1.2 Board Diagram

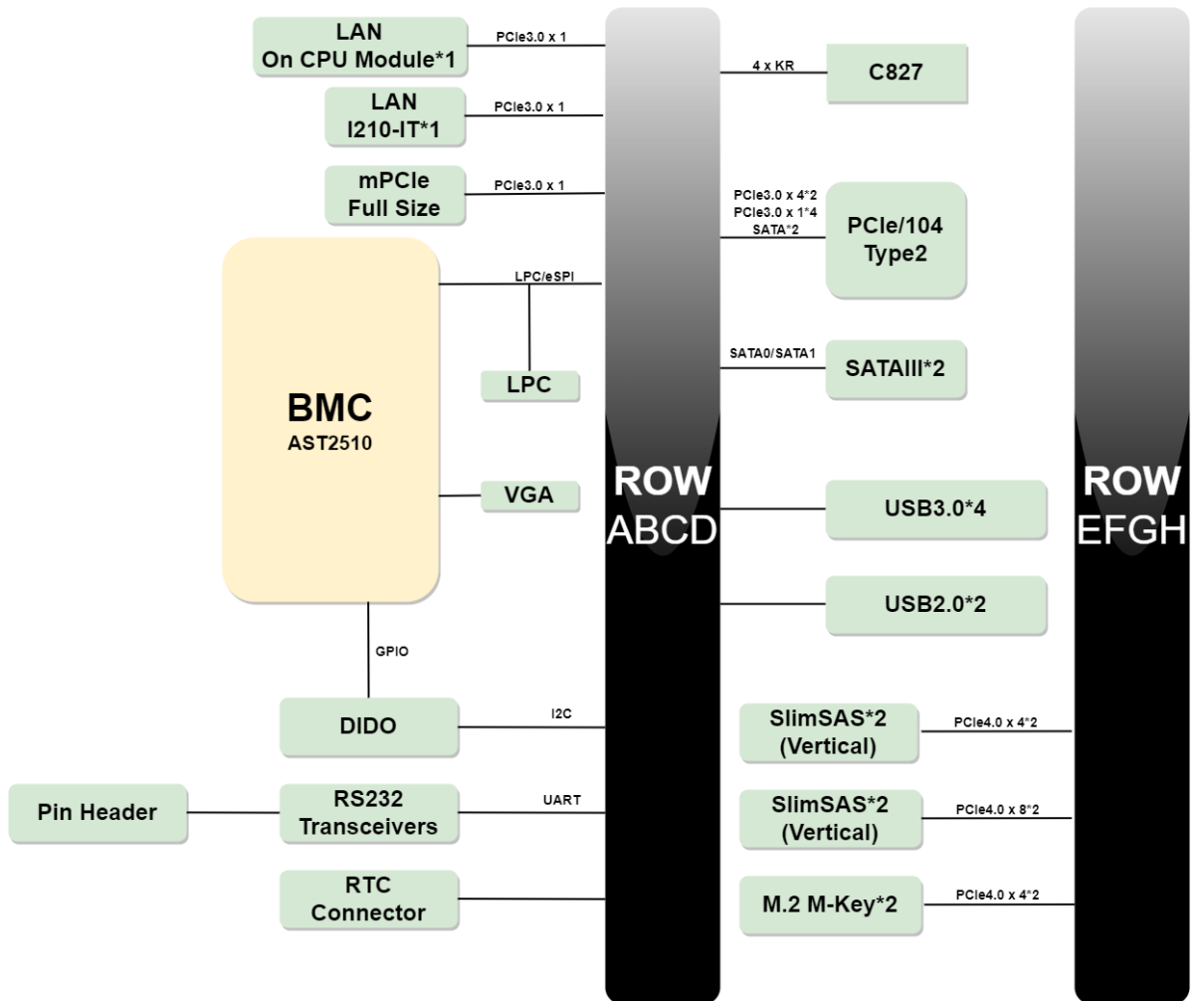

1.3 Dimension

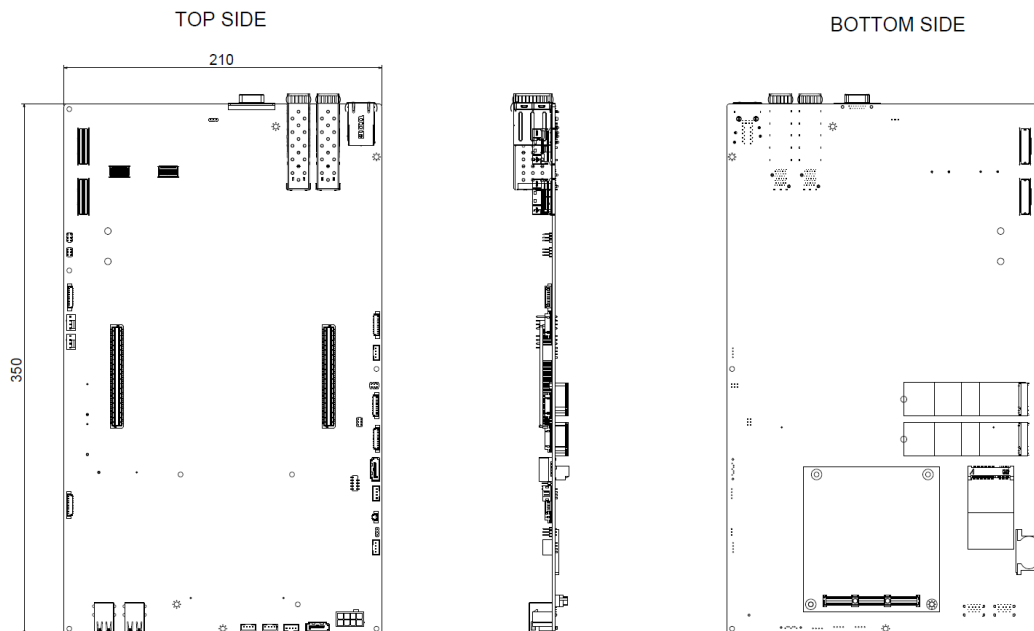

1.4 Appearance

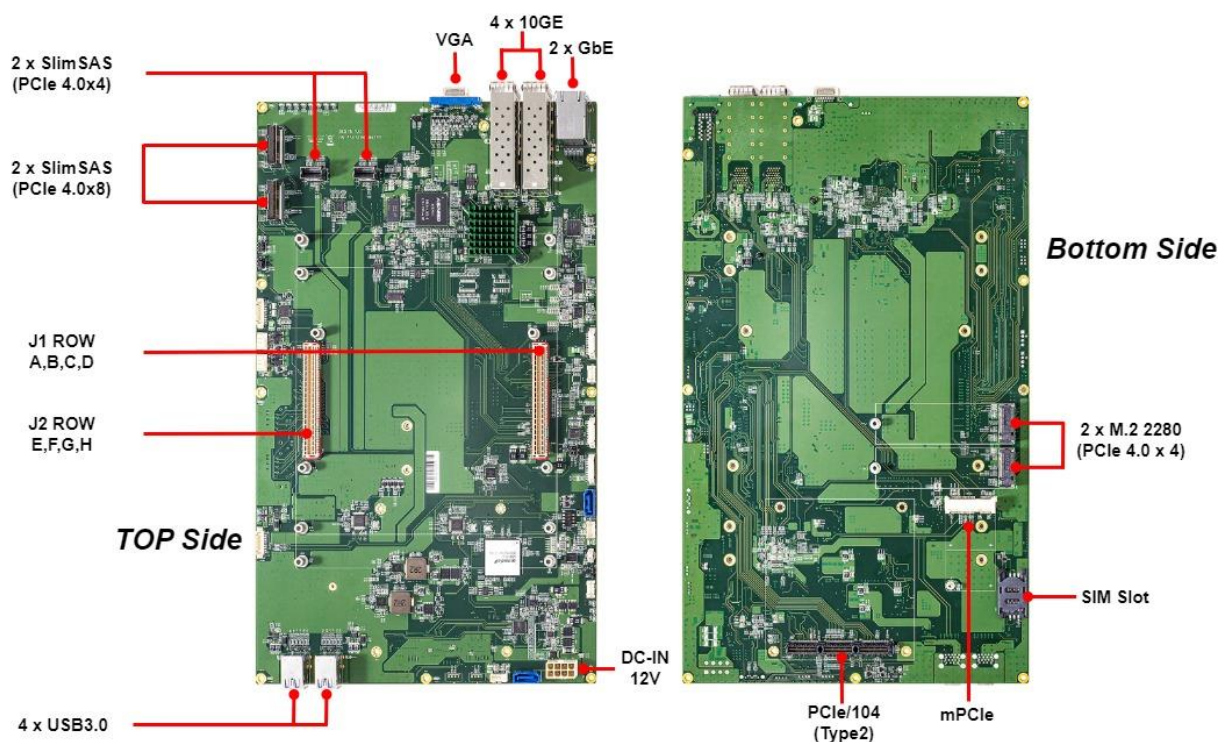

Chapter 2: Jumper and Connector setting

2.1 List of Jumpers / Internal Function Connector & Socket

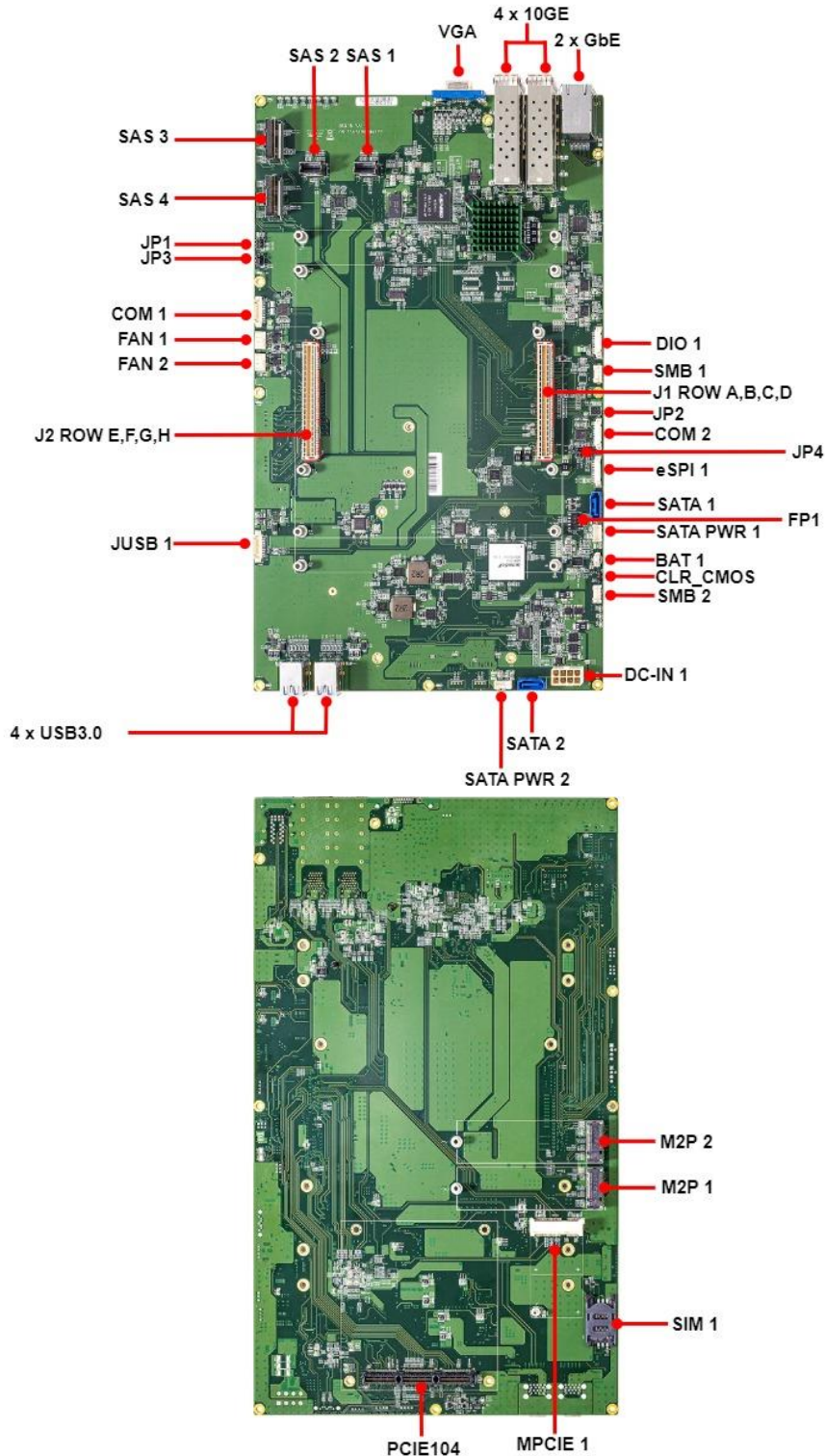

2.2 Jumper Setting

Clear CMOS

Function	Setting	
Default	1-2	
Clear CMOS	2-3	

JP1 : COM1 Pin 9 Function Select : 1A

Function	Setting	
5V	1-2	
12V	2-3	
NC	Open	

JP2 : COM2 Pin 9 Function Select : 1A

Function	Setting	
5V	1-2	
12V	2-3	
NC	Open	

JP3,JP4 : COM1,2 Function Select : RS232/422/485

Function	Setting	
RS232	1-3,4-6	
RS422	1-3,2-4	
RS485	3-5,2-4	

2.3 Connector Pin Assignment

DC_IN : DC Input Power Connector (12V/20A)

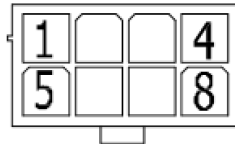

Pin	Signal	Pin	Signal
1	GND	2	GND
3	GND	4	GND
5	+12VSB	6	+12VSB
7	+12VSB	8	+12VSB

USB1,2 : 2 Port USB3.0 Type-A Connector

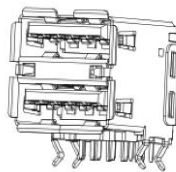

Pin	Signal Follow Standard
-----	------------------------

10GSFP1,2 : 2 Port 10G SFP+ LAN Connector (Type 1)

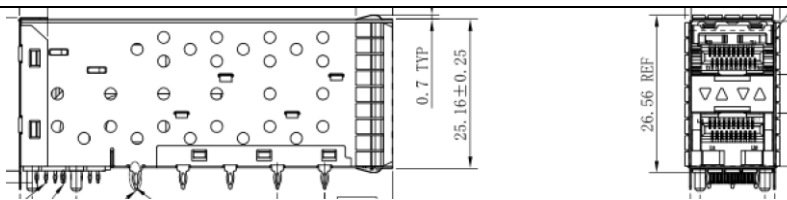

Pin	Signal Follow Standard	(Non LED)
-----	------------------------	-----------

SK518 User's Manual

Revision Date: Jan 18 2024

LAN1 : 2 Port GbE RJ-45 Connector

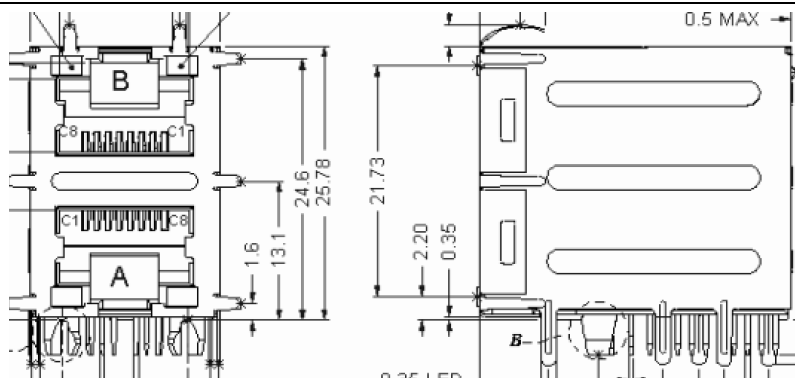

Pin Signal Follow Standard

P.S.: LAN LED Define:

Yellow : Active

1000M : Orange

100M : Green

VGA1 : Slim D-SUB 15 Pin VGA Connector

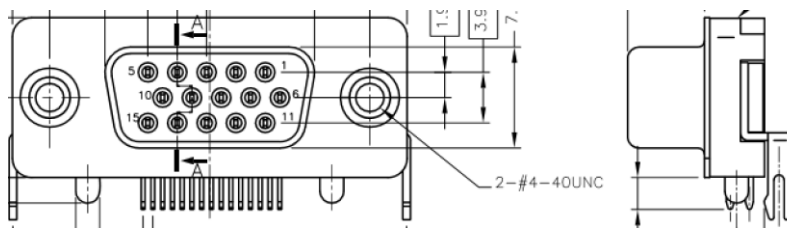

Pin Signal Follow Standard

SK518 User's Manual

Revision Date: Jan 18 2024

CPU Module Connector

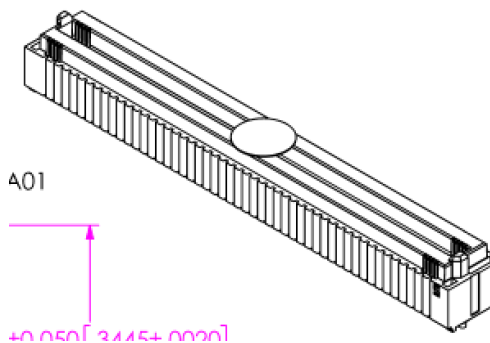

Pin Signal Follow Standard

M2P1,2 : M.2 M-key Socket 2280 for SSD

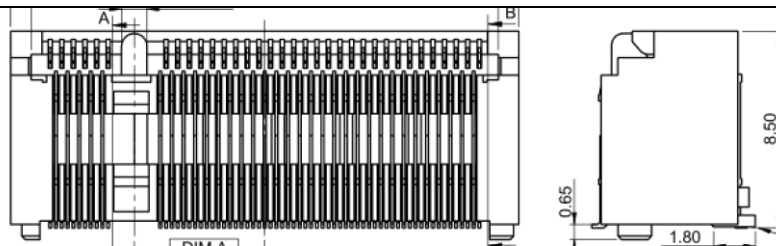

Pin Signal Follow Standard

MPCIE1: Mini PCIe Socket

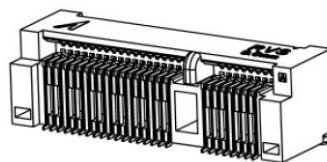

Pin Signal Follow Standard

SIM1: 6 pin SIM Socket

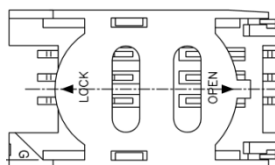

Pin Signal Follow Standard

SATA1,2 : 7 Pin DIP SATA Connector

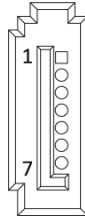

Pin	Signal Follow Standard
-----	------------------------

SATA_PWR1,2 : 4 Pin SATA Power Connector

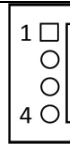

Pin	Signal
1	12V/1A
2	GND
3	GND
4	5V/1A

SAS1,2 : Slim SAS(x4) PCIe Gen4 Extension Connector

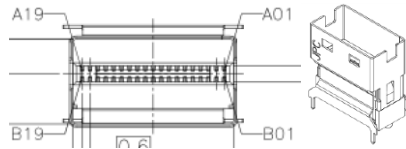

Pin	Signal	Pin	Signal
A1	GND	B1	GND
A2	PERp0	B2	PETp0
A3	PERn0	B3	PETn0
A4	GND	B4	GND
A5	PERp1	B5	PETp1
A6	PERn1	B6	PETn1
A7	GND	B7	GND
A8	BP_TYPE(VSP)	B8	2W-CLK
A9	CWAKE#,OBFF(VSP)	B9	2W-DATA
A10	GND	B10	GND
A11	REFCLK+(VSP+)	B11	PERST#(VSP)
A12	REFCLK-(VSP-)	B12	CPRSNT#(VSP)
A13	GND	B13	GND
A14	PERp2	B14	PETp2
A15	PERn2	B15	PETn2
A16	GND	B16	GND

SK518 User's Manual

Revision Date: Jan 18 2024

A17	PERp3	B17	PETp3
A18	PERn3	B18	PETn3
A19	GND	B19	GND

SAS3,4 : Slim SAS(x8) PCIe Gen4 Extension Connector

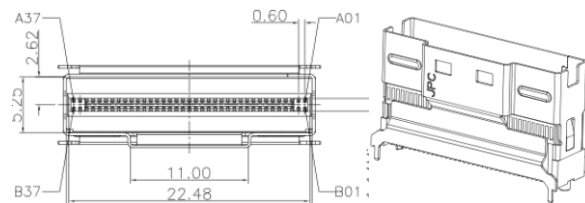

Pin	Signal	Pin	Signal
A1	GND	B1	GND
A2	PERp0	B2	PETp0
A3	PERn0	B3	PETn0
A4	GND	B4	GND
A5	PERp1	B5	PETp1
A6	PERn1	B6	PETn1
A7	GND	B7	GND
A8	BP_TYPEA(VSP)	B8	SMCLK
A9	WAKE#	B9	SMDAT
A10	GND	B10	GND
A11	REFCLK1A+	B11	PERST#
A12	REFCLK1A-	B12	CPRSNT1A#
A13	GND	B13	GND
A14	PERp2	B14	PETp2
A15	PERn2	B15	PETn2
A16	GND	B16	GND
A17	PERp3	B17	PETp3
A18	PERn3	B18	PETn3
A19	GND	B19	GND
A20	PERp4	B20	PETp4
A21	PERn4	B21	PETn4
A22	GND	B22	GND
A23	PERp5	B23	PETp5
A24	PERn5	B24	PETn5
A25	GND	B25	GND
A26	BP_TYPEB(VSP)	B26	SMCLK
A27	WAKE#	B27	SMDAT
A28	GND	B28	GND
A29	REFCLK1B+	B29	PERST#
A30	REFCLK1B-	B30	CPRSNT1B#
A31	GND	B31	GND

SK518 User's Manual

Revision Date: Jan 18 2024

A32	PERp6	B32	PETp6
A33	PERn6	B33	PETn6
A34	GND	B34	GND
A35	PERp7	B35	PETp7
A36	PERn7	B36	PETn7
A37	GND	B37	GND

COM1,2 : RS232/422/485 Serial Port Connector

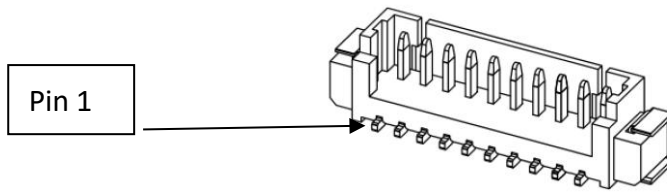

Pin	Signal(RS232)	Signal(RS422)	Signal(RS485)
1	5V/1A	5V/1A	5V/1A
2	GND	GND	GND
3	P9SEL/1A	P9SEL/1A	P9SEL/1A
4	N.C.	RX-	CTS
5	CTS	N.C.	N.C.
6	TXD	RX+	N.C.
7	RTS	N.C.	N.C.
8	RXD	TX+	Data+
9	N.C.	N.C.	N.C.
10	N.C.	TX-	Data-

DIO1: Digital I/O (3.3V Level) Connector

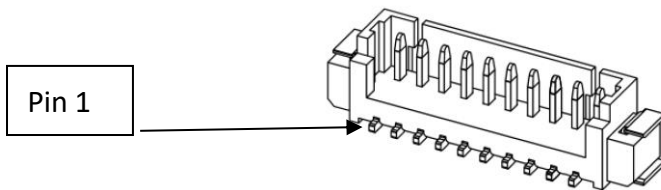

Pin	Signal	Pin	Signal
1	DI1	2	DI2
3	DI3	4	DI4
5	DO1	6	DO2
7	DO3	8	DO4
9	3.3V/1A	10	GND

SK518 User's Manual

Revision Date: Jan 18 2024

eSPI1 : eSPI Connector

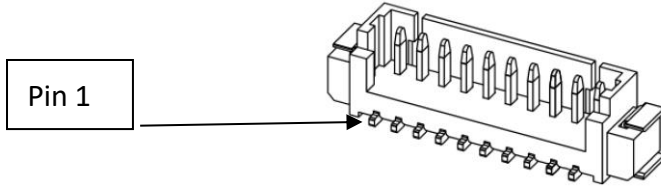

Pin	Signal	Pin	Signal
1	ESPI_ALERT	2	ESPI_CS0
3	ESPI_IO0	4	ESPI_IO1
5	ESPI_IO2	6	ESPI_IO3
7	ESPI_RST	8	ESPI_CLK.
9	1.8V/0.3A	10	GND

JUSB1 : 2 Port USB 2.0 Internal Connector

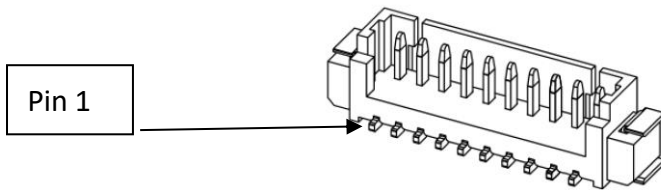

Pin	Signal	Pin	Signal
1	USB_VCC	2	USB_N1
3	USB_P1	4	GND
5	GND	6	USB_VCC
7	USB_N2	8	USB_P2
9	GND	10	GND

FP1 : Front Panel Pin Header(SMD 2.0mm)

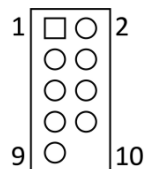

Pin	Signal	Pin	Signal
1	HDD_LED+	2	PW_LED+
3	HDD_LED-	4	GND
5	GND	6	PANSWIN#(Non USE)
7	RESET#	8	GND
9	NC	10	NC

SK518 User's Manual

Revision Date: Jan 18 2024

FAN1,2 : CPU/System FAN Connector

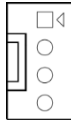

Pin	Signal
1	FAN_PWM
2	FAN_IO
3	12V/1A
4	GND

SMB1 : SMBus Link(2.0mm Box Header)



Pin	Signal
1	3.3V/1A
2	SMB_DATA
3	SMB_CLK
4	GND

SMB2 : For Debug Card(2.0mm Box Header)



Pin	Signal
1	3.3V/1A
2	SMB_DATA
3	SMB_CLK
4	GND

PCIe104 : PCIe104 Type2 Connector

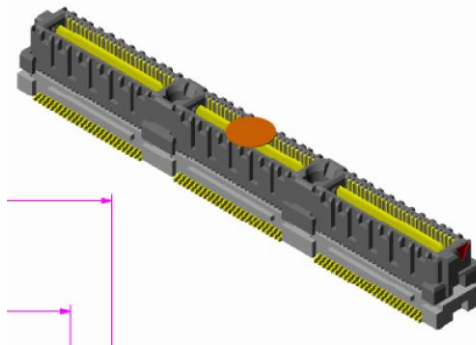

Pin	Signal Follow Standard
-----	------------------------

SK518 User's Manual

Revision Date: Jan 18 2024

BAT1 : CMOS 3.3V Battery Input(1.25mm BOX header)

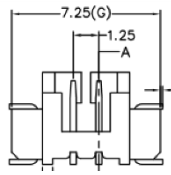

Pin	Signal
1	GND
2	3.3V

Function LED

LED	Function
1	Input Power LED
2	3.3V LED
3	5V LED
