

TEST REPORT

Project No.: TM-2403000345P
Applicant: PERFECTRON Co., Ltd.
Address: 2F., No.190, Sec 2, Zhongxing Rd., Xindian Dist.,
 New Taipei City, 23146, Taiwan.
Manufacturer: PERFECTRON Co., Ltd.
Address: 2F., No.190, Sec 2, Zhongxing Rd., Xindian Dist.,
 New Taipei City, 23146, Taiwan.
Equipment Under Test (EUT):
Name: MICRO-GRID COMPUTER
Brand Name: PERFECTRON
Model No.: SCH4X2-A9
Added Model(s): N/A

Standards:

EN 55032: 2015 + A11: 2020 + A1: 2020, Class A CISPR 32: 2015 + A1: 2019	BS EN 55032: 2015 + A11: 2020 + A1: 2020
EN IEC 61000-3-2: 2019 + A1: 2021	BS EN IEC 61000-3-2: 2019 + A1: 2021
EN 61000-3-3: 2013 + A1: 2019 + A2: 2021 + AC: 2022	BS EN 61000-3-3: 2013 + A1: 2019 + A2: 2021
EN 55035: 2017 + A11: 2020	BS EN 55035: 2017 + A11: 2020
IEC 61000-4-2: 2008	IEC 61000-4-6: 2013 + COR1: 2015
IEC 61000-4-3: 2020 (Ed. 4.0)	IEC 61000-4-8: 2009
IEC 61000-4-4: 2012	IEC 61000-4-11: 2020 + COR1: 2020 + COR2: 2022 (Ed. 3.0)
IEC 61000-4-5: 2014 + A1: 2017	

Date of Sample Receipt : March 20, 2024
Date of Test : April 26, 2024 ~ May 24, 2024
Date of Issue : November 12, 2024

Remarks:

This test report can be used for CE and UKCA marking application which is based on equivalent requirements between UK and EU. It is appropriate using designated standards to provide presumption of conformity with GB law.
 This report shall not be reproduced except in full, without approval of the Compliance Certification Services Inc. in writing. This document may be altered or revised by Compliance Certification Services Inc. personnel only. The applicant should not use it to claim product endorsement by TAF or any other Government agencies.

Disclaimer

Variants information between/among model numbers / trademarks is provided by the applicant, test results of this test report are applicable to the sample EUT received of main test model name

Approved By

 Jason Lee (Section Manager)

Date

November 12, 2024



Unless otherwise stated the results shown in this test report refer only to the sample(s) tested and such sample(s) are retained for 90 days only.

除非另有說明，此報告結果僅對測試之樣品負責，同時此樣品僅保留 90 天。本報告未經本公司書面許可，不可部份複製。

This document is issued by the Company subject to its General Conditions of Service printed overleaf, available on request or accessible at <http://www.sgs.com.tw/Terms-and-Conditions> and, for electronic format documents, subject to Terms and Conditions for Electronic Documents at <http://www.sgs.com.tw/Terms-and-Conditions>. Attention is drawn to the limitation of liability, indemnification and jurisdiction issues defined therein. Any holder of this document is advised that information contained hereon reflects the Company's findings at the time of its intervention only and within the limits of client's instruction, if any. The Company's sole responsibility is to its Client and this document does not exonerate parties to a transaction from exercising all their rights and obligations under the transaction documents. This document cannot be reproduced, except in full, without prior written approval of the Company. Any unauthorized alteration, forgery or falsification of the content or appearance of this document is unlawful and offenders may be prosecuted to the fullest extent of the law.

Revision History

Revision	Report Number	Description	Issue Date
00	TMXD2403001041DE	Original.	November 12, 2024

Note:

Contents

1. GENERAL DESCRIPTION	4
1.1 GENERAL DESCRIPTION OF EUT	4
1.2 DETAILS OF EUT	4
1.3 DESCRIPTION OF SUPPORT UNITS	5
1.4 I/O PORT DESCRIPTION.....	5
1.5 DECISION OF TEST MODE.....	6
1.6 THE FINAL TEST MODE OF THE EUT	6
1.7 CONFIGURATION OF TESTED SYSTEM	7
1.8 OPERATION PROCEDURE	7
1.9 SUMMARY OF RESULTS	8
1.10 REPORTING STATEMENTS OF CONFORMITY	8
1.11 DEVIATION.....	8
2. EMISSION.....	9
2.1 LIMIT	9
2.2 CONDUCTED EMISSION	11
2.3 RADIATED EMISSION	15
3. HARMONICS.....	19
3.1 TEST INSTRUMENTS	19
3.2 MEASUREMENT DATA.....	20
4. FLICKER.....	23
4.1 TEST INSTRUMENTS	23
4.2 MEASUREMENT DATA.....	24
5. IMMUNITY	25
5.1 STANDARD PERFORMANCE CRITERIA DESCRIPTION.....	25
5.2 SPECIAL PERFORMANCE CRITERIA DESCRIPTION	26
5.3 TEST OF IEC 61000-4-2	32
5.4 TEST OF IEC 61000-4-3	37
5.5 TEST OF IEC 61000-4-4	39
5.6 TEST OF IEC 61000-4-5	40
5.7 TEST OF IEC 61000-4-6	41
5.8 TEST OF IEC 61000-4-8	42
5.9 TEST OF IEC 61000-4-11	43
APPENDIX.....	44
PHOTOGRAPH OF TESTING GENERAL SET-UP	44
PHOTOGRAPHS OF EUT UNIT.....	53

1. General Description

1.1 General Description of EUT

Name of EUT	MICRO-GRID COMPUTER
Brand Name	PERFECTRON
Model No.(s)	SCH4X2-A9
Added Model(s)	N/A

1.2 Details of EUT

EUT Power Rating	110~240V 200W
Highest internal frequency	1000MHz

Accessories Cable List

Cable Type	Core	Length	Category	Shielding/Non-shielding

1.3 Description of Support Units

EUT Devices:

No.	Equipment	Model No.	Brand Name
1	MB	INS8367A	Perfector
2	CPU(1.0GHz)	i9-13900TE	Intel
3	Memory(64 GB)(DDR4 SO-DIMM)	NA	DSL
4	Storage(SATA SSD)(256 G)	NA	Phison
5	Power	UHP-200-12	Meanwell

Peripherals Devices:

No.	PRODUCT	MANUFACTURER	MODEL NO.	SERIAL NO.
1-4	USB HDD	Transcend	TS1TSJ25MC	N/A
5	USB Mouse	LOGITECH	M-U0026	N/A
6	USB Keyboard	LOGITECH	Y-U0011	1804SY04FP48
7	Monitor	ASUS	MX27UC	K8LMR024567
8	Monitor	GIGABYTE	M28U	SN21490B004523
9	Server PC	Dell	T3610	57TT032
10	Server PC	Dell	Precision 3640 Tower	FQNLFF3
11	Ground	N/A	N/A	N/A

Support Equipment Used in Tested Cable

No.	Cable Type	Core	Length	Shielding/Non-shielding
1-4	USB	N/A	1.4m	Shielding
5	USB	N/A	1.8m	Shielding
6	USB	N/A	1.8m	Shielding
7	DP	N/A	1.8m	Shielding
8	DP	N/A	1.8m	Shielding
9	RJ45	N/A	20m	Non-shielding
10	RJ45	N/A	20m	Non-shielding
11	Ground	N/A	1.8m	Non-shielding

1.4 I/O Port Description

I/O Port Types	Q'TY
1. USB Port	6
2. LAN Port	2
3. Display Port	2

1.5 Decision of Test Mode

The test configuration modes are as the following:

Conduction Modes (Power port):

1	DP*2 3840*2160@60Hz	100VAC, 50Hz
2	DP*2 3840*2160@60Hz	230VAC, 50Hz

Conduction Modes (Wired network ports):

1	LAN 1	10Mbps
2		100Mbps
3		1Gbps
4	LAN 2	10Mbps
5		100Mbps
6		1Gbps

Radiation Modes:

1	DP*2 3840*2160@60Hz	100VAC, 50Hz
2	DP*2 3840*2160@60Hz	230VAC, 50Hz
	DP*2 3840*2160@60Hz / 1-5GHz	

1.6 The Final Test Mode of the EUT

After the preliminary scan, the following test mode was found to produce the highest emission level.

Final Test Mode	
Conducted Emission	Mode 2
ISN	Mode 4
Radiated Emission Below 1GHz	Mode 2
Radiated Emission Above 1GHz	Mode 2
Harmonics & Flicker	Mode 2
Immunity	Mode 2

Then, the above highest emission mode of the configuration of the EUT and cable was chosen for all final test items.

1.7 Configuration of Tested System

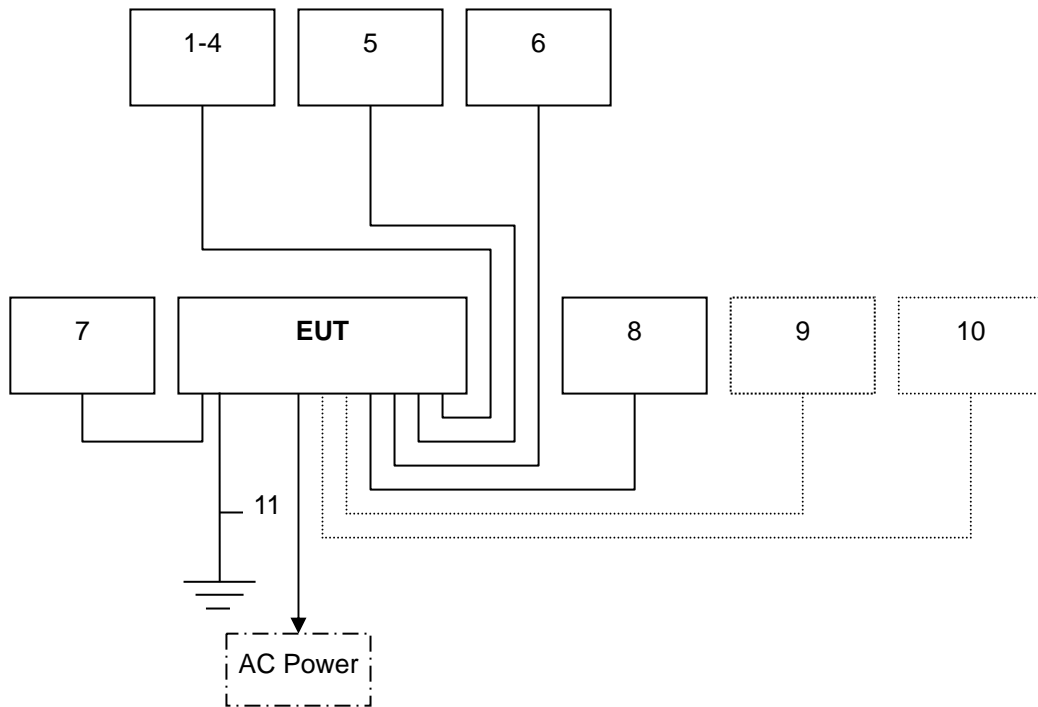

1.8 Operation Procedure

1. Windows 10 boots system.
2. Run colorbarmove.mp4 to activate all peripherals for test EUT.
3. Run Burnintest.exe to activate all peripherals to test EUT.
4. Run Lantest20.exe to ping 192.168.1.20&42 -t (EUT), ping 192.168.1.1&10 -t (Server PC).

1.9 Summary of Results

Emission		
Standard	Test Type	Result
EN 55032: 2015 + A11: 2020 + A1: 2020 CISPR 32: 2015 + A1: 2019 BS EN 55032: 2015 + A11: 2020 + A1: 2020	Conducted Emission	PASS
	ISN	PASS
	Radiated Emission	PASS
EN IEC 61000-3-2: 2019 + A1: 2021 BS EN IEC 61000-3-2: 2019 + A1: 2021	Harmonic current emissions	PASS
EN 61000-3-3: 2013 + A1: 2019 + A2: 2021 + AC: 2022 BS EN 61000-3-3: 2013 + A1: 2019 + A2: 2021	Voltage changes, voltage fluctuations & flicker	PASS

Immunity			
Standard	Test Type	Result	Performance Criteria
IEC 61000-4-2: 2008	ESD	PASS	B
IEC 61000-4-3: 2020 (Ed. 4.0)	RS	PASS	A
IEC 61000-4-4: 2012	EFT	PASS	B
IEC 61000-4-5: 2014 + A1: 2017	Surge	PASS	B
IEC 61000-4-6: 2013 + COR1: 2015	CS	PASS	A
IEC 61000-4-8: 2009	PFMF	N/A	A
IEC 61000-4-11: 2020 + COR1: 2020 + COR2: 2022 (Ed. 3.0)	DIP	PASS	C/C/B

1.10 Reporting Statements of Conformity

The conformity statement in this report is based solely on the test results, measurement uncertainty is excluded.

1.11 Deviation

No deviation from the mentioned test methods and applicable standards.

2.EMISSION

2.1 Limit

Maximum permissible level of Line Conducted Emission

FREQUENCY (MHz)	Class A(dBuV)		Class B(dBuV)	
	Quasi-peak	Average	Quasi-peak	Average
0.15 - 0.5	79	66	66 - 56	56 - 46
0.50 - 5.0	73	60	56	46
5.0 - 30.0	73	60	60	50

Note: The lower limit shall apply at the transition frequency.

Maximum permissible level of Common Mode Conducted Emission (Asymmetric Mode)

Class A

FREQUENCY (MHz)	Voltage Limit(dBuV)		Current Limit(dBuA)	
	Quasi-peak	Average	Quasi-peak	Average
0.15 - 0.5	97 - 87	84 - 74	53 - 43	40 - 30
0.5 - 30.0	87	74	43	30

Class B

FREQUENCY (MHz)	Voltage Limit(dBuV)		Current Limit(dBuA)	
	Quasi-peak	Average	Quasi-peak	Average
0.15 - 0.5	84 - 74	74 - 64	40 - 30	30 - 20
0.5 - 30.0	74	64	30	20

Note: The lower limit shall apply at the transition frequency.

Maximum permissible level of Radiated Emission measured at 10 meter

FREQUENCY (MHz)	Class A(dBuV/m)	Class B(dBuV/m)
	Quasi - peak	Quasi - peak
30 - 230	40	30
230 - 1000	47	37

Note: The lower limit shall apply at the transition frequency.

Maximum permissible level of Radiated Emission measured at 3 meter

Frequency range (MHz)	Class A(dBuV/m)	Class B(dBuV/m)
	Quasi - peak	Quasi - peak
30 - 230	50	40
230 - 1000	57	47

Note: The lower limit shall apply at the transition frequency.

Limits above 1 GHz

Limits for radiated disturbance of Class A ITE at a measurement distance of 3m

Frequency range (GHz)	Average Limit dB(μ V/m)	Peak Limit dB(μ V/m)
1 - 3	60	80
3 - 6	60	80

Note: The lower limit applies at the transition frequency.

Limits for radiated disturbance of Class B ITE at a measurement distance of 3m

Frequency range (GHz)	Average Limit dB(μ V/m)	Peak Limit dB(μ V/m)
1 - 3	54	74
3 - 6	54	74

Note: The lower limit applies at the transition frequency.

Requirements for radiated emissions from FM receivers

Frequency range (MHz)	Measurement				Class B Limit dB(μ V/m)
	Facility	Distance (m)	Detector type / Bandwidth	Fundamental	Harmonics
30 - 230	OATS/SAC	10	Quasi Peak / 120 kHz	50	42
230 - 300					42
300 - 1000					46
30 - 230	OATS/SAC	3	Quasi Peak / 120 kHz	60	52
230 - 300					52
300 - 1000					56

These relaxed limits apply only to emissions at the fundamental and harmonic frequencies of the LO. Signals at all other frequencies shall be compliant with the limits

Note: SAC: Semi Anechoic Chamber

OATS: Open Area Test Site

2.2 Conducted Emission

2.2.1 Test Instruments

Conducted Emission Room # B					
EQUIPMENT TYPE	Manufacturer	Model Number	Serial Number	Calibration Date	Calibration Due
Attenuator	MCL	HAT-10	SD-C012	03/18/2024	03/17/2025
BNC Cable	EMEC	CFD300-NL	SD-C020	12/28/2023	12/27/2024
EMI Test Receiver	R&S	ESR3	102166	03/05/2024	03/04/2025
LISN	Schwarzbeck	NSLK 8127	01082	03/13/2024	03/12/2025
LISN(EUT)	Schwarzbeck	NSLK 8127	01084	03/13/2024	03/12/2025
Thermo-Hygro Meter	Wisewind	N/A	SD-S017	08/16/2023	08/15/2024
ISN	Teseq	ISN T800	30847	03/13/2024	03/12/2025
Test S/W	EZ-EMC Ver.CCS-03A1				
Testing Site : No.163-1, Jhongsheng Rd., Xindian Dist., New Taipei City, Taiwan					
Measurement Uncertainty of Conducted Emission					
Expanded uncertainty U _{lab} (k=2) of Conducted Emission is 2.8 dB.					
Expanded uncertainty U _{lab} (k=2) of ISN Conducted Emission is 3.1 dB.					
Expanded uncertainty CISPR 16-4-2:2011+A1:2014+A2:2018 (k=2) of Conducted Emission measurement is 3.8 dB.					
Expanded uncertainty CISPR 16-4-2:2011+A1:2014+A2:2018 (k=2) of ISN Conducted Emission measurement is 5.0 dB.					

2.2.2 Measurement Level Calculation

Factor = LISN insertion loss + Cable loss + Pulse Limiter insertion loss

Measurement Level = Reading Level + Factor

Over (Margin) = Measurement Level – Limit

2.2.3 Measurement Data (CE)

Model No.	SCH4X2-A9	6dB Bandwidth	9 kHz
Environmental Conditions	22.5°C, 61% RH	Test Mode	Mode 2
Tested by	Jacky Lin	Phase	L1
Standard	EN 55032 CLASS A	Test Date	2024/04/26

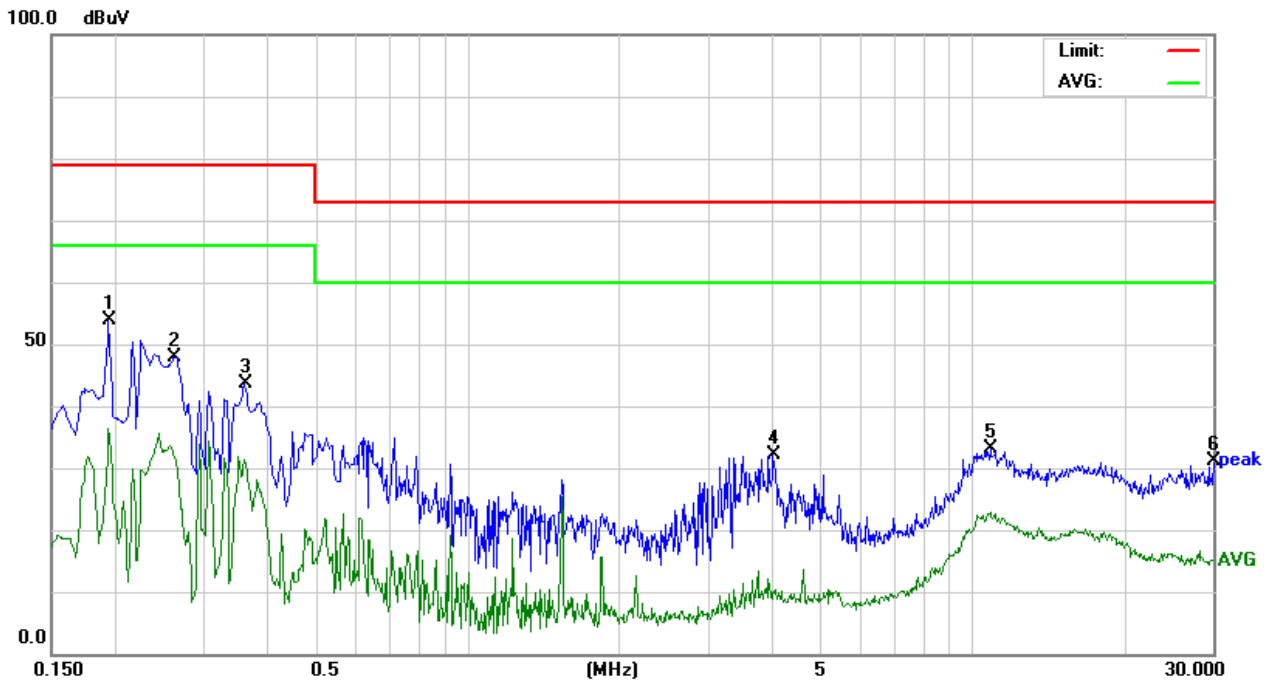

Conducted Emission Readings							
Frequency Range Investigated				150 kHz to 30 MHz			
Freq. (MHz)	Reading (dBuV)	Factor (dB)	Result (dBuV)	Limit (dBuV)	Margin (dB)	Detector (P/Q/A)	Line (L1/L2)
0.1949	43.82	9.99	53.81	79.00	-25.19	P	L1
0.2625	37.88	9.99	47.87	79.00	-31.13	P	L1
0.3615	33.57	10.00	43.57	79.00	-35.43	P	L1
4.0290	21.88	10.26	32.14	73.00	-40.86	P	L1
10.8915	22.46	10.58	33.04	73.00	-39.96	P	L1
30.0000	19.51	11.61	31.12	73.00	-41.88	P	L1

Note: 1. L1 = Line One (Live Line) / L2 = Line Two (Neutral Line).

Model No.	SCH4X2-A9	6dB Bandwidth	9 kHz
Environmental Conditions	22.5°C, 61% RH	Test Mode	Mode 2
Tested by	Jacky Lin	Phase	L2
Standard	EN 55032 CLASS A	Test Date	2024/04/26

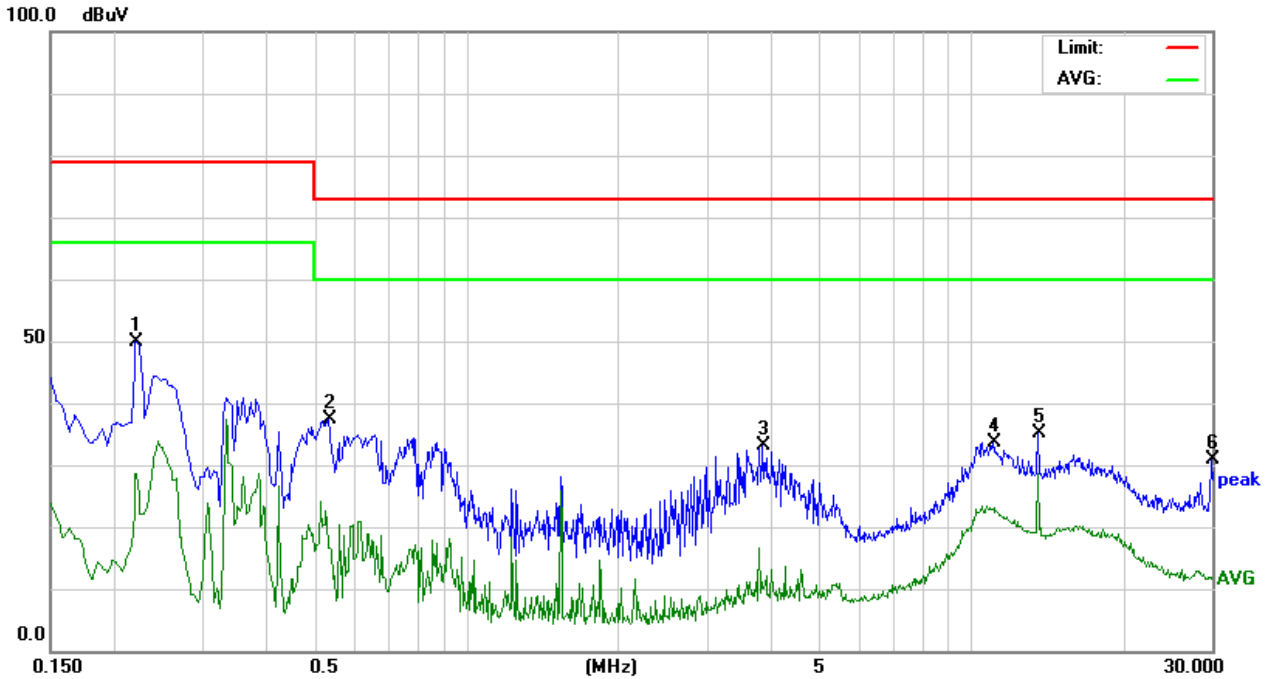

Conducted Emission Readings							
Frequency Range Investigated				150 kHz to 30 MHz			
Freq. (MHz)	Reading (dBuV)	Factor (dB)	Result (dBuV)	Limit (dBuV)	Margin (dB)	Detector (P/Q/A)	Line (L1/L2)
0.2220	39.93	9.98	49.91	79.00	-29.09	P	L2
0.5325	27.28	9.98	37.26	73.00	-35.74	P	L2
3.8670	22.86	10.27	33.13	73.00	-39.87	P	L2
11.0355	23.14	10.59	33.73	73.00	-39.27	P	L2
13.5600	24.47	10.70	35.17	73.00	-37.83	P	L2
29.8725	19.44	11.47	30.91	73.00	-42.09	P	L2

Note: 1. L1 = Line One (Live Line) / L2 = Line Two (Neutral Line).

2.2.4 Measurement Data (ISN)

Model No.	SCH4X2-A9	6dB Bandwidth	9 kHz
Environmental Conditions	22.5°C, 61% RH	Test Mode	Mode 4
Tested by	Jacky Lin	Test Date	2024/04/26
Standard	EN 55032 CLASS A		

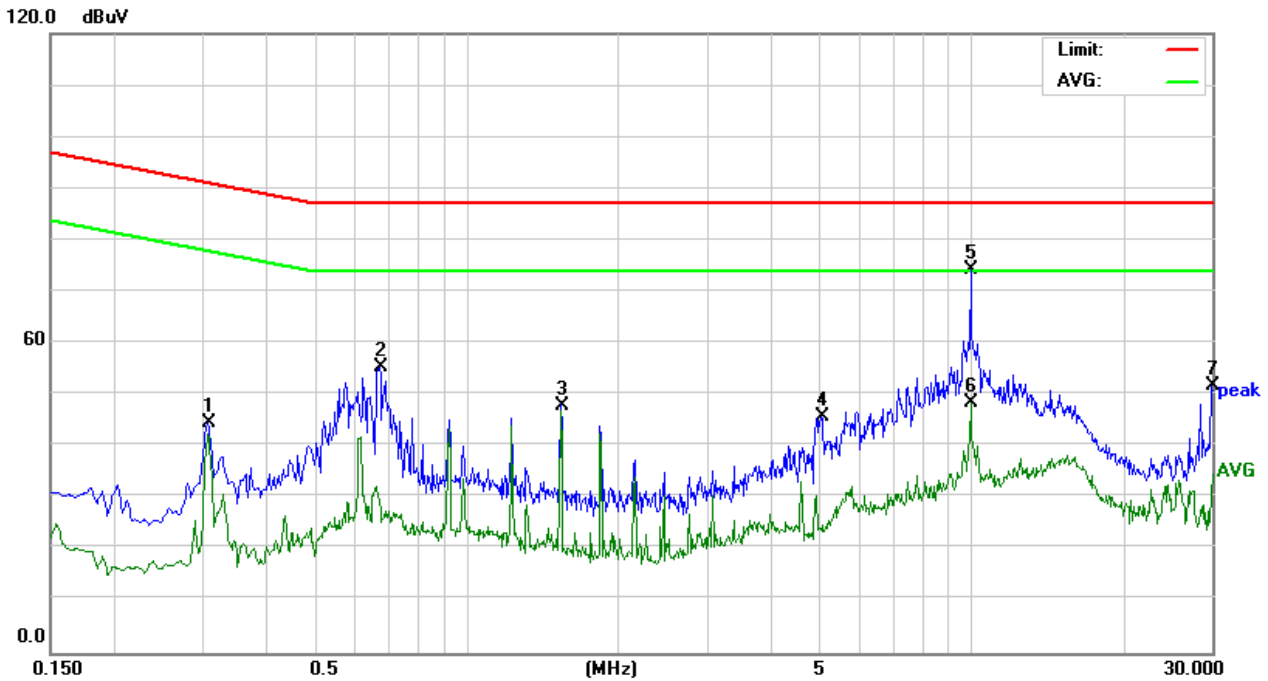

Conducted Emission Readings						
Frequency Range Investigated				150 kHz to 30 MHz		
Freq. (MHz)	Reading (dBuV)	Factor (dB)	Result (dBuV)	Limit (dBuV)	Margin (dB)	Detector (P/Q/A)
0.3075	24.88	19.80	44.68	91.04	-46.36	P
0.6720	35.62	19.66	55.28	87.00	-31.72	P
1.5405	28.32	19.68	48.00	87.00	-39.00	P
5.0370	25.94	19.72	45.66	87.00	-41.34	P
10.0050	54.34	19.78	74.12	87.00	-12.88	P
10.0050	28.80	19.78	48.58	74.00	-25.42	A
29.9985	31.40	20.34	51.74	87.00	-35.26	P

2.3 Radiated Emission

2.3.1 Test Instruments

Below 1GHz

Open Area Test Site # H					
EQUIPMENT TYPE	Manufacturer	Model Number	Serial Number	Calibration Date	Calibration Due
Bilog Antenna	Teseq	CBL 6112D	36995	06/13/2023	06/12/2024
Cable	EMEC	CFD400E-LW	SD-R074	08/10/2023	08/09/2024
EMI Test Receiver	R&S	ESCI	101340	01/22/2024	01/21/2025
Pre-Amplifier	HP	8447D	1937A01554	09/21/2023	09/20/2024
Thermo-Hygro Meter	Wisewind	201A	No. 03	05/23/2023	05/22/2024
Test S/W	EZ-EMC Ver.CCS-03A1				
Testing Site : No.163-1, Jhongsheng Rd., Xindian Dist., New Taipei City, Taiwan					
Measurement Uncertainty of Radiated Emission					
Expanded uncertainty U _{lab} (k=2) of Radiated Emission is 5.1 dB.(30MHz-1000MHz)					
Expanded uncertainty CISPR 16-4-2:2011+A1:2014+A2:2018 (k=2) of Radiated Emission measurement is 5.2 dB.(30MHz-1000MHz)					

Above 1GHz

Chamber # E					
EQUIPMENT TYPE	Manufacturer	Model Number	Serial Number	Calibration Date	Calibration Due
Horn Antenna	ETS-Lindgren	3117	00139062	06/08/2023	06/07/2024
Microflex Cable x 7m	JMT	LF01	SD-R089	06/07/2023	06/06/2024
K-Type Cable x 1m	JMT	LK01	SD-R087	06/07/2023	06/06/2024
Pre-Amplifier	Com-Power	PAM-118A	551041	06/07/2023	06/06/2024
Signal Analyzer	R&S	FSV40	101269	06/07/2023	06/06/2024
Thermo-Hygro Meter	Wisewind	201A	SD-R046	07/24/2023	07/23/2024
Test S/W	EZ-EMC Ver.CCS-03A1				
Testing Site : No.163-1, Jhongsheng Rd., Xindian Dist., New Taipei City, Taiwan					
Measurement Uncertainty of Radiated Emission					
Expanded uncertainty (k=2) of Radiated Emission measurement is 4.6 dB.(1-6GHz)					
Expanded uncertainty CISPR 16-4-2:2011+A1:2014+A2:2018 (k=2) of Radiated Emission measurement is 5.5 dB.(1-6GHz)					

2.3.2 Measurement Level Calculation

Correction Factor = Antenna Factor + Cable loss- Amplifier Gain
 Measurement Level = Reading Level + Correction Factor
 Over (Margin) = Measurement Level – Limit

2.3.3 Measurement Data

Below 1GHz

Model No.	SCH4X2-A9	Test Mode	Mode 2
Environmental Conditions	19.9°C, 71% RH	6dB Bandwidth	120 kHz
Antenna Pole	Vertical	Antenna Distance	10m
Detector Function	Quasi-peak.	Tested by	Jacky Lin
Standard	EN 55032 CLASS A	Test Date	2024/04/27

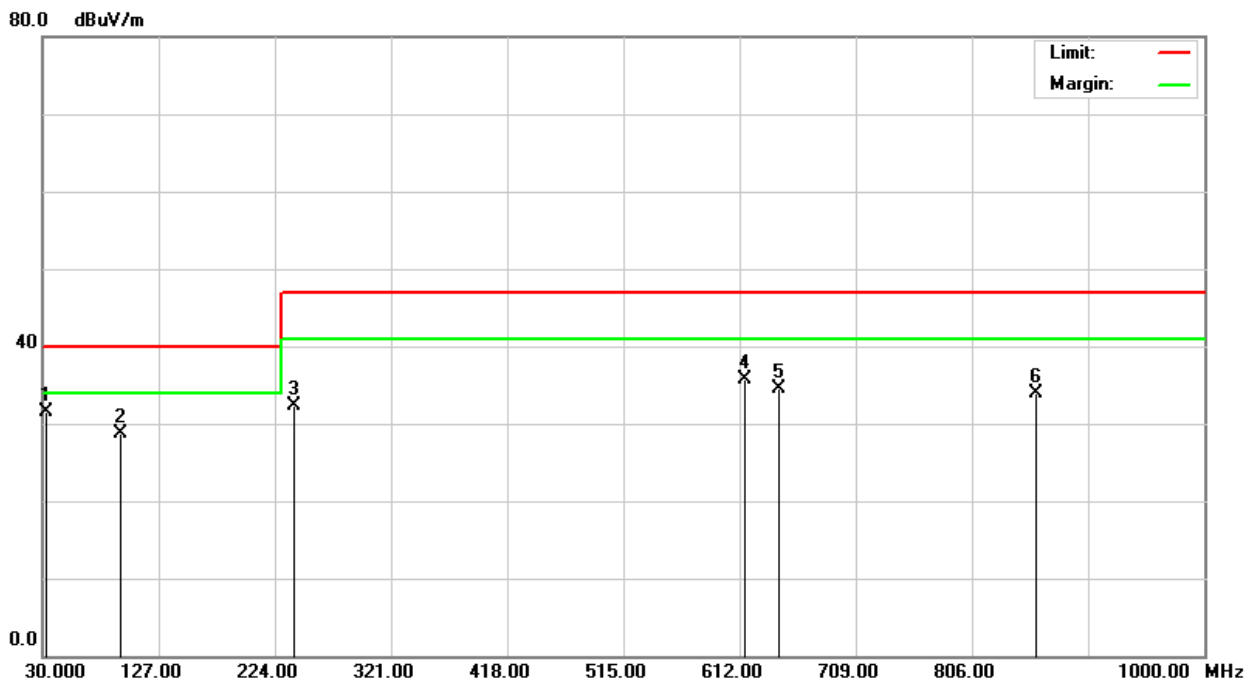

Radiated Emission Readings									
Frequency Range Investigated				30 MHz to 1000 MHz at 10m					
Freq. (MHz)	Reading (dBuV)	Factor (dB/m)	Result (dBuV/m)	Limit (dBuV/m)	Margin (dB)	Height (cm)	Degree (°)	Detector (P/Q)	Pol. (H/V)
33.8400	35.60	-4.10	31.50	40.00	-8.50	100	300	Q	V
95.0199	39.10	-10.41	28.69	40.00	-11.31	100	19	Q	V
239.9900	40.20	-7.88	32.32	47.00	-14.68	100	263	Q	V
615.9800	34.40	1.30	35.70	47.00	-11.30	400	87	Q	V
645.3100	32.90	1.55	34.45	47.00	-12.55	400	352	Q	V
859.7500	29.50	4.46	33.96	47.00	-13.04	400	120	Q	V

Note: 1. P= Peak Reading; Q= Quasi-peak Reading.

Model No.	SCH4X2-A9	Test Mode	Mode 2
Environmental Conditions	19.9°C, 71% RH	6dB Bandwidth	120 kHz
Antenna Pole	Horizontal	Antenna Distance	10m
Detector Function	Quasi-peak.	Tested by	Jacky Lin
Standard	EN 55032 CLASS A	Test Date	2024/04/27

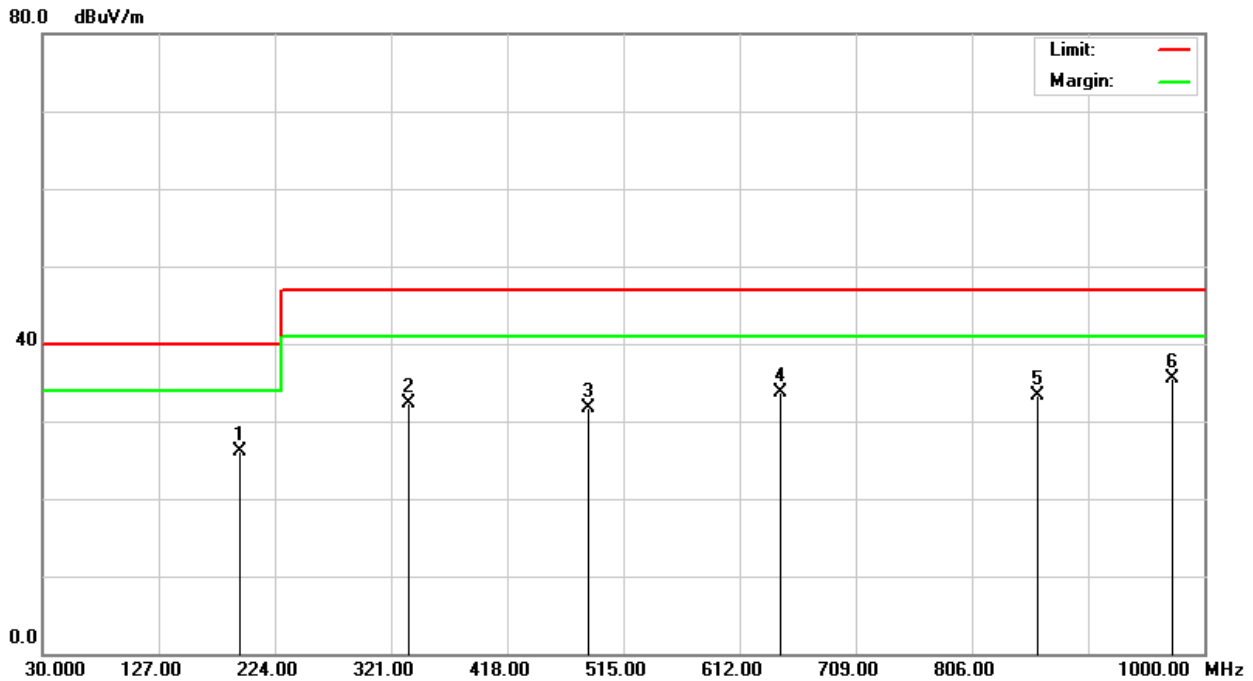

Radiated Emission Readings									
Frequency Range Investigated				30 MHz to 1000 MHz at 10m					
Freq. (MHz)	Reading (dBuV)	Factor (dB/m)	Result (dBuV/m)	Limit (dBuV/m)	Margin (dB)	Height (cm)	Degree (°)	Detector (P/Q)	Pol. (H/V)
195.2400	36.50	-10.43	26.07	40.00	-13.93	400	159	Q	H
336.1800	37.20	-4.92	32.28	47.00	-14.72	400	368	Q	H
486.0500	32.60	-0.83	31.77	47.00	-15.23	100	224	Q	H
646.7100	32.10	1.56	33.66	47.00	-13.34	100	15	Q	H
860.3400	28.90	4.47	33.37	47.00	-13.63	100	328	Q	H
972.9600	30.20	5.33	35.53	47.00	-11.47	100	105	Q	H

Note: 1. P= Peak Reading; Q= Quasi-peak Reading.

Above 1GHz

Model No.	SCH4X2-A9	Test Mode	Mode 2
Environmental Conditions	21.5°C, 62% RH	6dB Bandwidth	1 MHz
Antenna Pole	Vertical / Horizontal	Antenna Distance	3m
Highest frequency generated or used	1000MHz	Upper frequency	5000MHz
Detector Function	Peak and average.	Tested by	Jacky Lin
Standard	EN 55032 CLASS A	Test Date	2024/04/27

Radiated Emission Readings							
Frequency Range Investigated				Above 1GHz at 3m			
Freq. (MHz)	Reading (dBuV)	Factor (dB/m)	Result (dBuV/m)	Limit (dBuV/m)	Margin (dB)	Detector (P/A)	Pol. (H/V)
1155.000	60.28	-8.66	51.62	80.00	-28.38	P	V
1310.000	60.88	-8.16	52.72	80.00	-27.28	P	V
1685.000	59.58	-7.55	52.03	80.00	-27.97	P	V
2995.000	54.91	-4.05	50.86	80.00	-29.14	P	V

Radiated Emission Readings							
Frequency Range Investigated				Above 1GHz at 3m			
Freq. (MHz)	Reading (dBuV)	Factor (dB/m)	Result (dBuV/m)	Limit (dBuV/m)	Margin (dB)	Detector (P/A)	Pol. (H/V)
1240.000	58.83	-8.49	50.34	80.00	-29.66	P	H
1670.000	60.11	-7.60	52.51	80.00	-27.49	P	H
1865.000	56.68	-5.20	51.48	80.00	-28.52	P	H
2620.000	56.97	-4.34	52.63	80.00	-27.37	P	H
4000.000	55.94	-4.03	51.91	80.00	-28.09	P	H

Note: 1. P= Peak Reading; A= Average Reading.

3. Harmonics

3.1 Test Instruments

Immunity A					
EQUIPMENT TYPE	Manufacturer	Model Number	Serial Number	Calibration Date	Calibration Due
5kVA Power Source	Teseq	NSG 1007-5	1537A01296	01/04/2024	01/03/2025
Signal Conditioning Unit	Teseq	CCN 1000-1	1846A01831	01/04/2024	01/03/2025
Test Software	WIN2100V4 Ver. 4.22				
Testing Site : No.163-1, Jhongsheng Rd., Xindian Dist., New Taipei City, Taiwan					

3.2 Measurement Data

Test Result: Pass Source qualification: Normal

Current & voltage waveforms

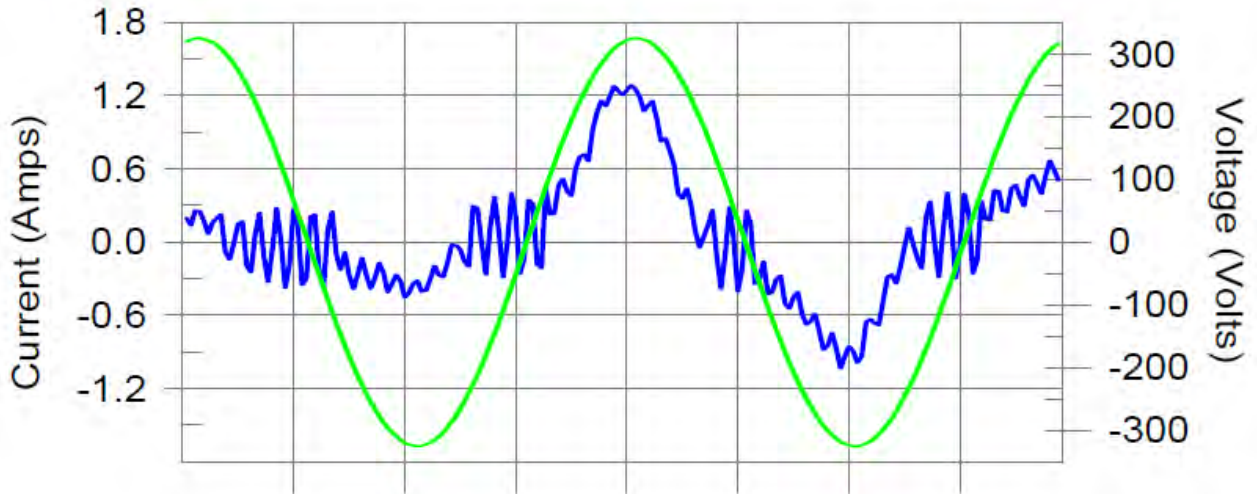

Harmonics and Class A limit line European Limits

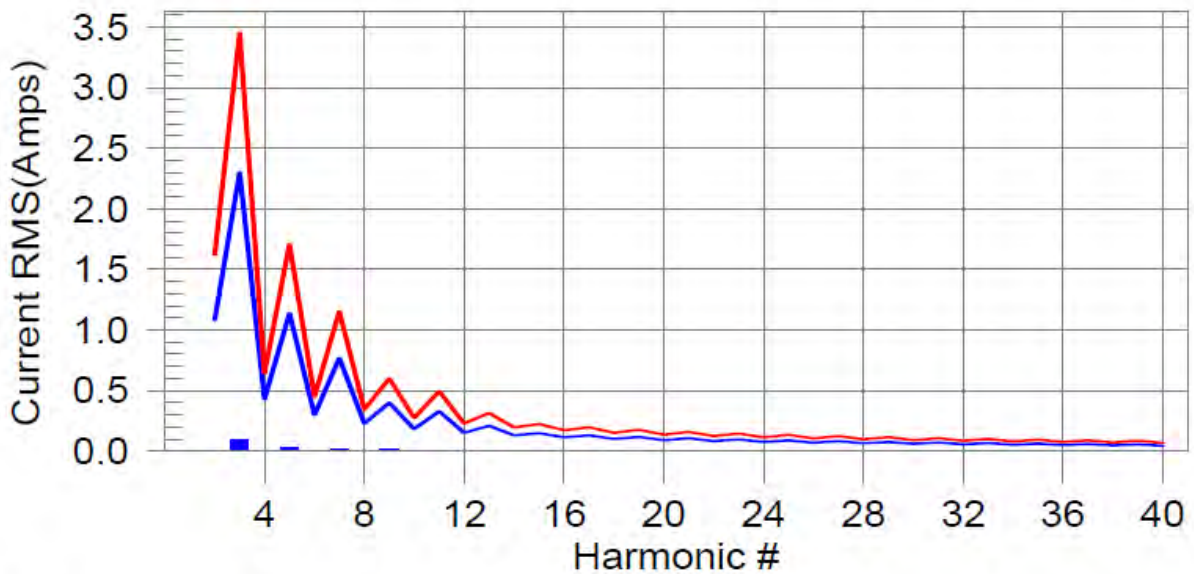

Test result: Pass Worst harmonics H29-5.8% of 150% limit, H29-6.5% of 100% limit

Test Result: Pass Source qualification: Normal
 THC(A): 0.102 I-THD(%): 30.6 POHC(A): 0.016 POHC Limit(A): 0.251

Highest parameter values during test:

V_RMS (Volts):	229.82	Frequency(Hz):	50.00
I_Peak (Amps):	1.389	I_RMS (Amps):	0.442
I_Fund (Amps):	0.334	Crest Factor:	4.315
Power (Watts):	71.6	Power Factor:	0.840

Harm#	Harms(avg)	100%Limit	%of Limit	Harms(max)	150%Limit	%of Limit	Status
2	0.009	1.080	0.8	0.024	1.620	1.5	Pass
3	0.091	2.300	3.9	0.105	3.450	3.1	Pass
4	0.006	0.430	1.4	0.013	0.645	2.0	Pass
5	0.032	1.140	2.8	0.037	1.710	2.2	Pass
6	0.004	0.300	N/A	0.009	0.450	N/A	Pass
7	0.016	0.770	2.1	0.018	1.155	1.6	Pass
8	0.003	0.230	N/A	0.006	0.345	N/A	Pass
9	0.010	0.400	2.6	0.012	0.600	2.0	Pass
10	0.003	0.184	N/A	0.006	0.276	N/A	Pass
11	0.010	0.330	3.1	0.011	0.495	2.3	Pass
12	0.003	0.153	N/A	0.005	0.230	N/A	Pass
13	0.008	0.210	3.6	0.009	0.315	2.7	Pass
14	0.003	0.131	N/A	0.004	0.197	N/A	Pass
15	0.007	0.150	4.5	0.007	0.225	3.2	Pass
16	0.003	0.115	N/A	0.004	0.173	N/A	Pass
17	0.006	0.132	4.7	0.007	0.198	3.5	Pass
18	0.003	0.102	N/A	0.004	0.153	N/A	Pass
19	0.006	0.118	4.8	0.007	0.178	3.7	Pass
20	0.003	0.092	N/A	0.004	0.138	N/A	Pass
21	0.006	0.107	5.2	0.007	0.161	4.6	Pass
22	0.003	0.084	N/A	0.004	0.125	N/A	Pass
23	0.005	0.098	5.3	0.006	0.147	4.2	Pass
24	0.003	0.077	N/A	0.004	0.115	N/A	Pass
25	0.005	0.090	5.6	0.006	0.135	4.2	Pass
26	0.003	0.071	N/A	0.004	0.107	N/A	Pass
27	0.005	0.083	6.1	0.006	0.125	4.6	Pass
28	0.004	0.066	N/A	0.005	0.099	N/A	Pass
29	0.005	0.078	6.5	0.007	0.116	5.8	Pass
30	0.004	0.061	N/A	0.004	0.092	N/A	Pass
31	0.005	0.073	N/A	0.006	0.109	N/A	Pass
32	0.004	0.058	N/A	0.005	0.086	N/A	Pass
33	0.005	0.068	N/A	0.006	0.102	N/A	Pass
34	0.004	0.054	N/A	0.004	0.081	N/A	Pass
35	0.004	0.064	N/A	0.005	0.096	N/A	Pass
36	0.003	0.051	N/A	0.004	0.077	N/A	Pass
37	0.004	0.061	N/A	0.005	0.091	N/A	Pass
38	0.003	0.048	N/A	0.004	0.073	N/A	Pass
39	0.004	0.058	N/A	0.005	0.087	N/A	Pass
40	0.002	0.046	N/A	0.003	0.069	N/A	Pass

Test Result: Pass Source qualification: Normal

Highest parameter values during test:

Voltage (Vrms):	229.82	Frequency(Hz):	50.00
I _{Peak} (Amps):	1.389	I _{RMS} (Amps):	0.442
I _{Fund} (Amps):	0.334	Crest Factor:	4.315
Power (Watts):	71.6	Power Factor:	0.840

Harm#	Harmonics V-rms	Limit V-rms	% of Limit	Status
2	0.046	0.460	10.08	OK
3	0.087	2.068	4.19	OK
4	0.020	0.460	4.37	OK
5	0.123	0.919	13.39	OK
6	0.029	0.460	6.25	OK
7	0.033	0.689	4.74	OK
8	0.008	0.460	1.81	OK
9	0.030	0.459	6.58	OK
10	0.010	0.460	2.11	OK
11	0.013	0.230	5.77	OK
12	0.014	0.230	6.11	OK
13	0.010	0.230	4.27	OK
14	0.005	0.230	2.27	OK
15	0.012	0.230	5.10	OK
16	0.006	0.230	2.61	OK
17	0.007	0.230	3.07	OK
18	0.012	0.230	5.04	OK
19	0.009	0.230	3.79	OK
20	0.024	0.230	10.49	OK
21	0.010	0.230	4.19	OK
22	0.004	0.230	1.78	OK
23	0.010	0.230	4.17	OK
24	0.004	0.230	1.78	OK
25	0.008	0.230	3.44	OK
26	0.004	0.230	1.83	OK
27	0.008	0.230	3.31	OK
28	0.003	0.230	1.51	OK
29	0.009	0.230	3.85	OK
30	0.006	0.230	2.45	OK
31	0.008	0.230	3.38	OK
32	0.003	0.230	1.49	OK
33	0.005	0.230	2.36	OK
34	0.003	0.230	1.30	OK
35	0.005	0.230	2.32	OK
36	0.003	0.230	1.46	OK
37	0.007	0.230	3.03	OK
38	0.003	0.230	1.41	OK
39	0.007	0.230	3.08	OK
40	0.016	0.230	6.85	OK

4. Flicker

4.1 Test Instruments

Immunity A					
EQUIPMENT TYPE	Manufacturer	Model Number	Serial Number	Calibration Date	Calibration Due
5kVA Power Source	Teseq	NSG 1007-5	1537A01296	01/04/2024	01/03/2025
Signal Conditioning Unit	Teseq	CCN 1000-1	1846A01831	01/04/2024	01/03/2025
Test Software	WIN2100V4 Ver. 4.22				
Testing Site : No.163-1, Jhongsheng Rd., Xindian Dist., New Taipei City, Taiwan					

4.2 Measurement Data

Test Result: Pass

Status: Test Completed

Pst and limit line

European Limits

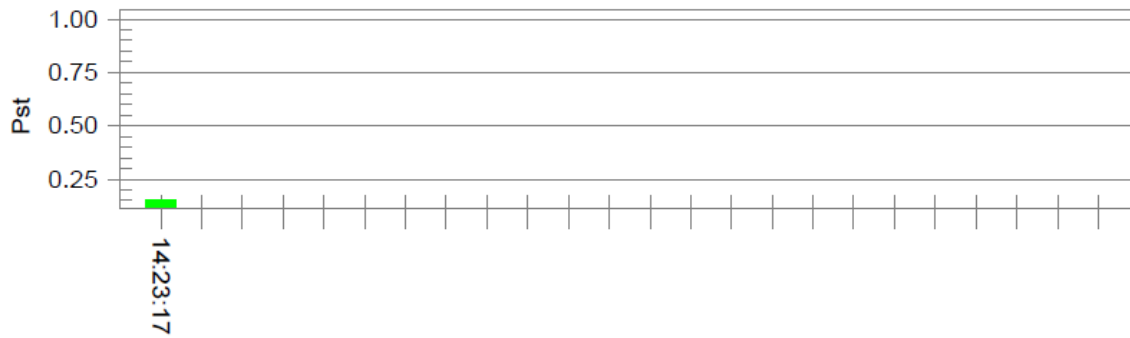

Plt and limit line

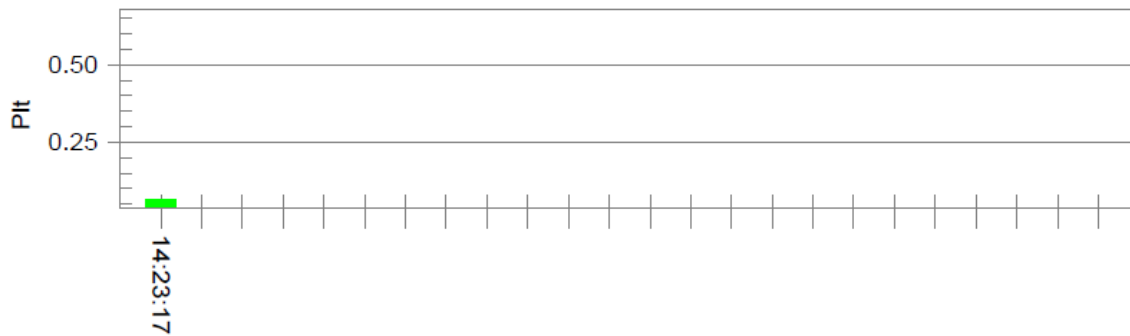

Parameter values recorded during the test:

Vrms at the end of test (Volt): 229.62

Highest dt (%):

T-max (mS): 0

Highest dc (%): 0.00

Highest dmax (%): 0.00

Highest Pst (10 min. period): 0.152

Highest Plt (2 hr. period): 0.067

Test limit (%):

Test limit (mS): 500.0 Pass

Test limit (%): 3.30 Pass

Test limit (%): 4.00 Pass

Test limit: 1.000 Pass

Test limit: 0.650 Pass

5.IMMUNITY

5.1 STANDARD PERFORMANCE CRITERIA DESCRIPTION

- Criterion A - The apparatus shall continue to operate as intended. No degradation of performance or loss of function is allowed below a performance level specified by the manufacturer, when the apparatus is used as intended.
- Criterion B - The apparatus shall continue to operate as intended after the test. No degradation of performance or loss of function is allowed below a performance level specified by the manufacturer, when the apparatus is used as intended.
- Criterion C - Temporary loss of function is allowed, provided the function is self recoverable or can be restored by the operation of the controls.

5.2 SPECIAL PERFORMANCE CRITERIA DESCRIPTION

5.2.1 Performance Criteria Description for Print function

Criterion A - Apply criterion A as defined in 8.2. Additionally, the following shall not occur as a consequence of the application of the disturbance:

- change of operating state;
- unintended pausing of the print operation;
- a change of print quality or legibility, as appropriate to the test pattern;
- change of character font;
- unintended line feed;
- unintended page feed;
- paper feed failure.

Criterion B - Apply criterion B as defined in 8.3 with the following specifics and additional limitations. Paper feed failures are allowed only if, after removal of the jammed sheets, the job is automatically recovered and there is no loss of printed information. Any low-quality print output caused by the application of the disturbance shall not continue beyond the sheet of media being printed, or beyond the typical length of a finished page or sheet printed from continuous roll media. False indicators are permitted during the test provided that a normal operator response to that false indicator is simple (such as pressing a button). False indicators are not acceptable if they would cause the user to discard printing supplies such as ink, toner or paper, when those supplies are actually not empty or faulty. Any false indicator shall either clear automatically or after the operator's response. After the disturbance, the print function may print the remainder of the print job at a quality level within the manufacturer's specifications. Alternately, the print function may halt processing of a print job as a result of the disturbance, but only if the operator is capable of reprinting the job (for example, a fax printing job where the image to be printed still resides in local memory). Automatically restarting the print job from the beginning is also acceptable. In any scenario, the pairing of front and back images during double-sided printing shall be correct.

Criterion C - Temporary loss of function is allowed, provided the function is self recoverable or can be restored by the operation of the controls.

5.2.2 Performance Criteria Description for Scan function

- Criterion A - Apply criterion A as defined in 8.2. Additionally, the following shall not occur as a consequence of the application of the test:
- change of settings, such as which side(s) of the page to be scanned, colour or monochrome, and resolution;
 - corruption of the image, for example stretching, compressing or change in colour;
 - paper feed failures;
 - errors in the reading of bar codes.
- Criterion B - Apply criterion B as defined in 8.3 with the following specifics and additional limitations.
- Document feed failures are allowed only if the original documents are undamaged and, after removal of the jammed sheets, the job is automatically recovered and there is no loss of scanned information.
 - During the test, the representation of the image shall not be degraded such that reading mistakes occur.
- Criterion C - Temporary loss of function is allowed, provided the function is self recoverable or can be restored by the operation of the controls.

5.2.3 Performance Criteria Description for Display and display output function

- Criterion A - Apply criterion A as defined in 8.2. Additionally, an increase in any degradation greater than just perceptible by observation of the image shall not occur as a consequence of the application of the test. Examples of such degradations are:
- superimposed patterning;
 - positional disturbances due to synchronisation errors;
 - geometric distortion;
 - change of contrast or brightness;
 - picture artefacts;
 - freezing or disturbance of motion;
 - image loss;
 - video data or decoding errors.
- Criterion B - The apparatus shall continue to operate as intended after the test. No degradation of performance or loss of function is allowed below a performance level specified by the manufacturer, when the apparatus is used as intended.
- Criterion C - Temporary loss of function is allowed, provided the function is self recoverable or can be restored by the operation of the controls.

5.2.4 Performance Criteria Description for Musical tone generating function

- Criterion A - Performance criterion A is subdivided according to the type of equipment and its use. Three subgroups corresponding to different equipment types are defined in Table E.1 and have corresponding performance criteria A1, A2 and A3. The relevant subgroup shall be selected by the manufacturer in accordance with the product specification. The description of criteria A1, A2 and A3 are presented in Table E.2.
- Criterion B - During the test, degradation of performance beyond that defined in criterion A1 of Table E.2 is allowed. However, sudden amplification of tone to a level that exceeds the expected level by more than 6 dB is not allowed. After the test, normal operation of the EUT shall be self-recovered. In the case of unintended tone holding caused by a MIDI protocol communication error, the EUT can be re-initialised by the operation of the controls by the user controls in accordance with the manufacturer's instructions. Due to the nature of the MIDI protocol, it is necessary to modify the performance criterion B to allow user intervention when the unintended tone holding is caused by a missing MIDI communication error (for example missing a 'NOTE OFF' message).
- Criterion C - Degradation of the performance beyond that defined in criterion A1 of Table E.2 is permitted provided that the normal operation of the EUT can be restored after the test by operator intervention. However, sudden amplification of tone to a level that exceeds the expected level by more than 6 dB is not allowed.

5.2.5 Performance Criteria Description for Networking function

Criterion A - Where relevant, during the application of the test the network function shall, as a minimum, operate ensuring that:

- established connections shall be maintained throughout the application of the test;
- no change of operational state or corruption of stored data occurs;
- no increase in error rate above the figure defined by the manufacturer occurs. The manufacturer should select the most appropriate performance measurement criteria for the product or system, for example bit error rate, block error rate;
- no request for retry above the figure defined by the manufacturer;.
- the data transmission rate does not reduce below the figure defined by the manufacturer;
- no protocol failure occurs;
- the audio noise level at a two-wire analogue interface (supporting telephony) shall satisfy the requirements of Table G.3. The audio level measurements shall be performed at the demodulated frequency of the disturbance using a narrowband filter with a 3 dB bandwidth of 100 Hz using the method defined in table clause G.1.4. See G.6.1. As described in the example given in J.3.5 the networking function is monitored during testing using direct functions specified elsewhere in this document. If needed to verify the operation of the protocol, the following functions shall be verified as described in Table H.1 when performing the additional spot frequency tests contained in Clause 5:
 - ability to establish a connection,
 - ability to clear a connection.

Where an EUT has supervisory functions they shall not be affected. Elements that should be monitored include, but are not limited to:

- alarms,
- signalling lamps,
- printer output errors,
- network traffic rates,
- network monitor errors,
- measured network parameters.

Criterion B - Established connections shall be maintained throughout the test, or shall self-recover in a way and timescale that is imperceptible to the user.

The error rate, request for retry and data transmission rates may be degraded during the application of the test. Degradation of the performance as described in criterion A is permitted, provided that the normal operation of the EUT is self-recoverable to the condition established prior to the application of the test. Where required, as defined in Clause 5, the acceptable operation of the function shall be verified at the completion of the test as described in Table H.1, by confirming the following:

- the EUT's ability to establish a connection,
- the EUT's ability to clear a connection.

During surge testing disconnection is allowed on the analogue/digital data port being tested. If the EUT is a supervisory equipment, it shall not impact the normal operation of the network being monitored. In addition, any supervisory functions impacted during the period of the test shall return to the state prior to the test. Elements to consider include:

- alarms,
- signalling lamps,
- printer output,
- network traffic rates,
- network monitoring. is used as intended.

Criterion C - Degradation of performance as described in criteria A and B is permitted provided that the normal operation of the EUT is self-recoverable to the condition immediately before the application of the test, or can be restored after the test by the operator.

5.2.6 Performance Criteria Description for Audio output function

- Criterion A - The interference ratio (electrical or acoustic) shall meet the limits in column 3; or,
the acoustic level of the demodulated audio shall be less than the limits in column 4; or,
the digitally coded level of demodulated audio shall be less than limits in column 5; or,
the analogue level of the demodulated audio shall be less than the limits in column 6.
- Criterion B - The apparatus shall continue to operate as intended after the test. No degradation of performance or loss of function is allowed below a performance level specified by the manufacturer, when the apparatus is used as intended.
- Criterion C - Temporary loss of function is allowed, provided the function is self recoverable or can be restored by the operation of the controls.

5.2.7 Performance Criteria Description for Telephony function

Function to be exercised	Performance criteria		
	A	B	C
Establish new communication	At the additional spot frequency tests a, c	Performed before and after the application of the test or disturbance	Performed before and after the application of the test or disturbance
Maintain established communication	Yes In addition, the requirements of Annex G for the audio output function shall be satisfied c	Yes b	No
Terminate established communication	At the additional spot frequency tests a, c	Performed before and after the application of the test or disturbance	Performed before and after the application of the test or disturbance

Communication refers to a telephone call or other form of voice connection.

a Applicable to TTE with a dial function that provides dedicated emergency service/safety of life call capability. Where the EUT does not provide this functionality, this limitation shall be stated in the equipment user manual.

b Communication shall be established prior to the application of the disturbance, the communication shall be maintained and the quality of that communication (for example, volume setting, the level of background noise) shall be maintained after completion of the test or disturbance.

c Where defined in Clause 5 (for the tests in Table 1 to Table 4), these functional tests shall be performed during the additional spot frequency tests.

5.3 Test of IEC 61000-4-2

5.3.1 Test Instruments

Immunity Shielded Room					
EQUIPMENT TYPE	Manufacturer	Model Number	Serial Number	Calibration Date	Calibration Due
Aneroid Barometer	SATO	7610-20	89090	07/24/2023	07/23/2024
ESD Simulator	Teseq	NSG 438	1581	07/09/2023	07/08/2024
Thermo-Hygro Meter	Wisewind	201A	SD-S041	12/12/2023	12/11/2024
Testing Site : No.163-1, Jhongsheng Rd., Xindian Dist., New Taipei City, Taiwan					

5.3.2 EUT Operating Condition

Environment:

Temperature	Humidity	Air Pressure
22.3 °C	48 %RH	1005 hpa

5.3.3 Results of Electrostatic Discharge Test (ESD)

Model No. : SCH4X2-A9
 Tested By : Richard Liang
 Tested Date : April 26, 2024
 Test Mode : Mode 2
 Basic Standard : IEC 61000-4-2
 Discharge Impedance : 330 ohm / 150 pF
 Discharge Voltage : Air Discharge: $\pm 2, 4, 8$ kV
 Contact Discharge: $\pm 2, 4$ kV
 HCP/VCP: $\pm 2, 4$ kV
 Polarity : Positive/Negative
 Number of Discharge : 10 times at each test point
 Discharge Mode : Single Discharge
 Discharge Period : 1 second

A.Observations:

Test points: 1. Front side. 2. Back side. 3. Left side. 4. Right side.
5. Top side. 6. Bottom side.

Direct Application			Test Results	
Discharge Level (kV)	Polarity (+/-)	Test Point	Contact Discharge	Air Discharge
2, 4, 8 (Air.)	+/-	1, 2	N/A	No discharge point
2, 4 (Cont.)	+/-	1~5	A	N/A

Remark: A: No degradation of performance or loss of function.
N/A: Not Applicable.

B.Observations:

Test points: 1. Front side. 2. Back side. 3. Left side. 4. Right side.

Indirect Application			Test Results	
Discharge Level (kV)	Polarity (+/-)	Test Point	Horizontal Coupling	Vertical Coupling
2, 4	+/-	1~4	A	A

Remark: A: No degradation of performance or loss of function.

ESD Test point

Front



Back

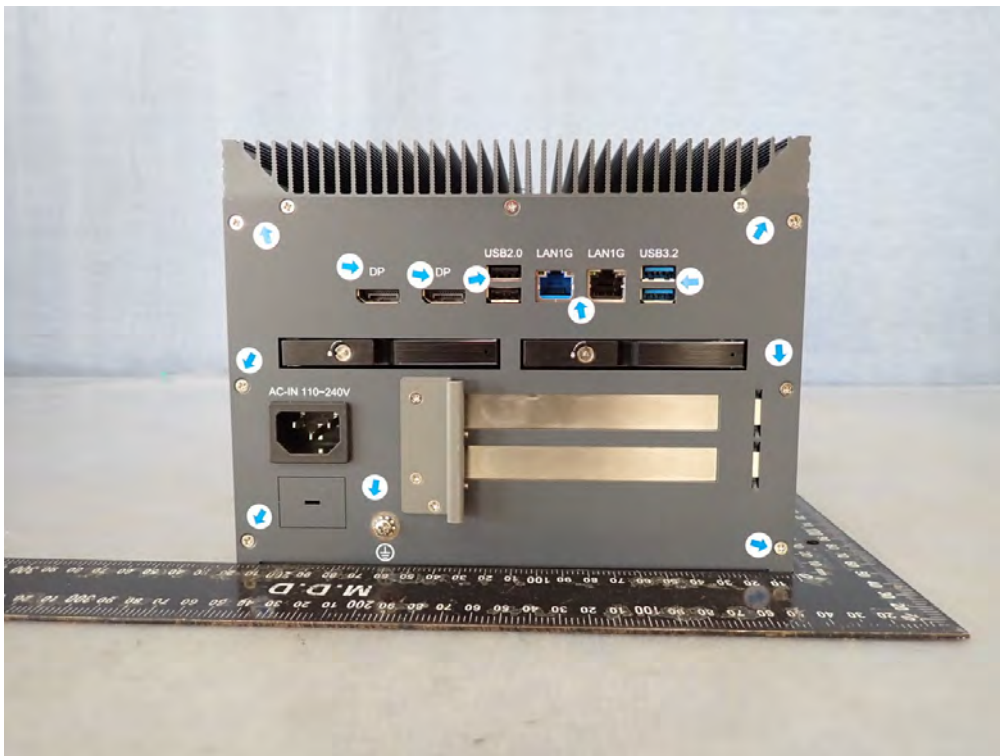

Air Discharge: ↑
Contact Discharge: ↑

Left

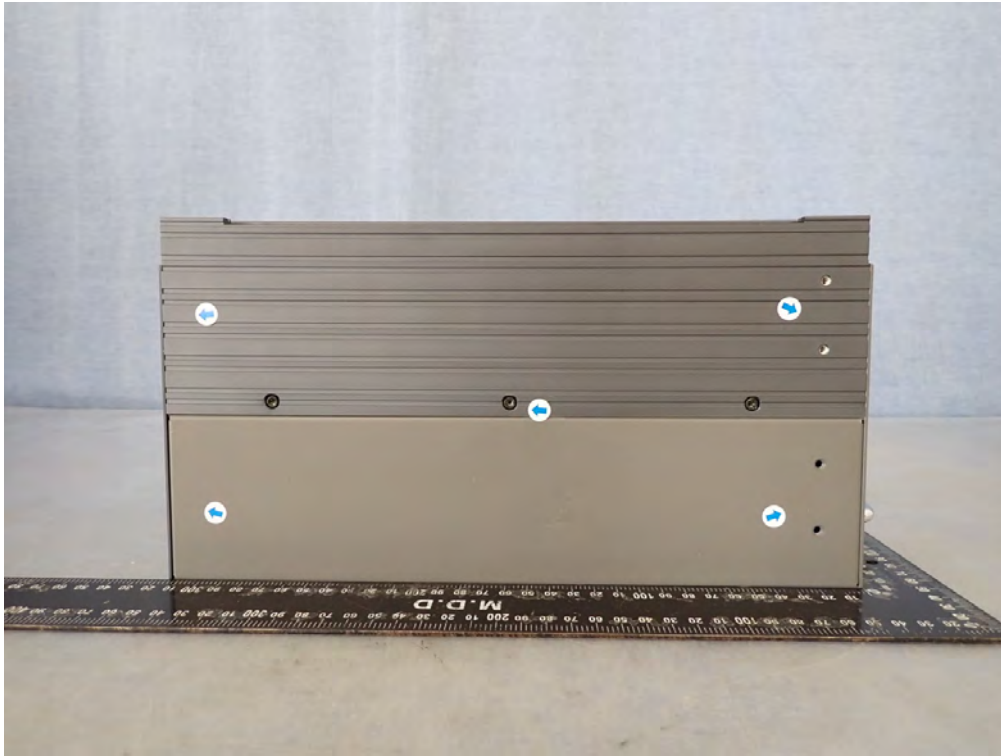

Right



Air Discharge: ↑
Contact Discharge: ↑

Top

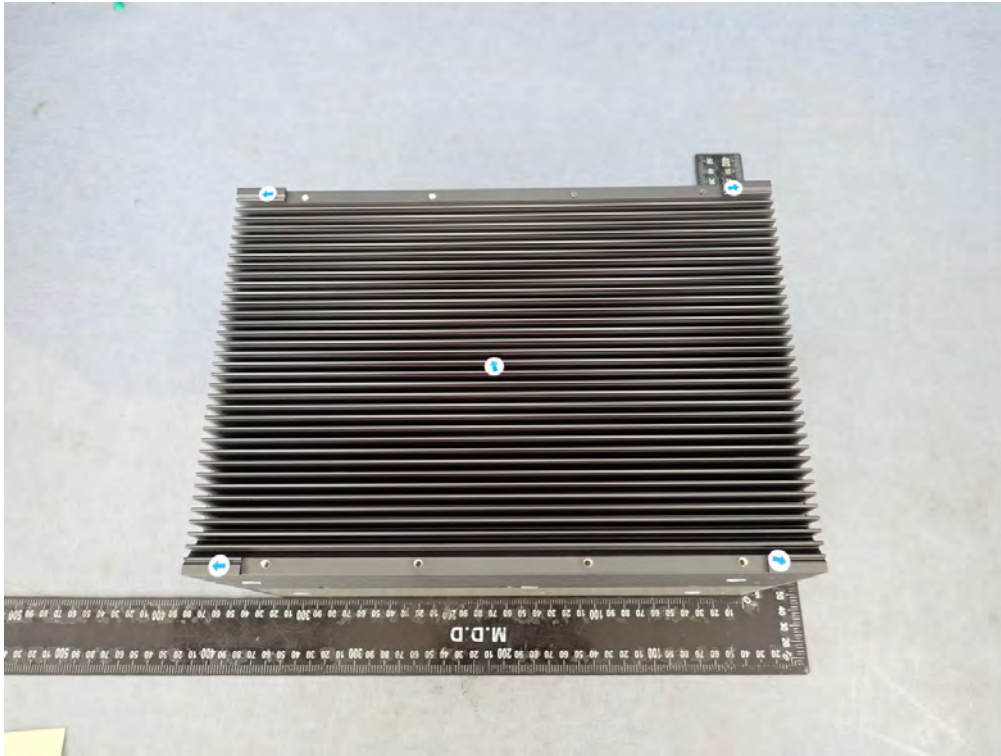

Air Discharge: ↑
Contact Discharge: ↑

5.4 Test of IEC 61000-4-3

5.4.1 Test Instruments

844 RS Chamber					
EQUIPMENT TYPE	Manufacturer	Model Number	Serial Number	Calibration Date	Calibration Due
Electric Field Probe	AR	FL7006	0356656	03/06/2024	03/07/2025
Field of Calibration	CCS	Chamber#RS	80-1000MHz	02/16/2024	02/15/2025
RF Power Meter	Boonton	4242	17419	01/29/2024	01/28/2025
Power Sensor	Boonton	51011A-EMC	36833	01/29/2024	01/28/2025
Power Sensor	Boonton	51011A-EMC	36834	01/29/2024	01/28/2025
Thermo-Hygro Meter	Wisewind	N/A	SD-S019	09/21/2023	09/20/2024
Broadband Antenna	AR	AT1080	311819	N.C.R	N.C.R
Power Amplifier	Teseq	CBA1G-600D	1098099	N.C.R	N.C.R
Analog Signal Generator	Agilent	E8257D	MY48051214	06/05/2023	06/04/2024
Field of Calibration	CCS	Chamber#RS	1000-6000MHz	02/15/2024	02/14/2025
Microwave Antenna	Schwarzbeck	STLP 9149	767	N.C.R	N.C.R
Power Amplifier	Teseq	CBA6G-100D	1087370	N.C.R	N.C.R
Test Software	EmcwareVer. 3.2				
Testing Site : No.163-1, Jhongsheng Rd., Xindian Dist., New Taipei City, Taiwan					

5.4.2 EUT Operating Condition

Environment:

Temperature	Humidity	Air Pressure
23.7 °C	56 %RH	1009 hpa

5.4.3 Results of Radiated Radio Frequency Electromagnetic (RS)

Model No. : SCH4X2-A9
 Tested By : Long Liao
 Tested Date : May 24, 2024
 Test Mode : Mode 2
 Basic Standard : IEC 61000-4-3
 Frequency range : 80 MHz - 1000 MHz
 Frequency range : 1800 MHz, 2600 MHz, 3500 MHz, 5000 MHz ($\pm 1\%$)
 Field strength : 3 V/m
 Modulation : 80% AM (1kHz)
 Frequency step : 1 % of the preceding frequency
 Polarity of Antenna : Horizontal and Vertical
 Dwell Time : 3 seconds
 Test distance : 3 m

No.	Frequency (MHz)	Antenna Orientation	Observation	EUT Orientation
1	80 - 1000	Vertical/Horizontal	A	0 degree
2	80 - 1000	Vertical/Horizontal	A	90 degree
3	80 - 1000	Vertical/Horizontal	A	180 degree
4	80 - 1000	Vertical/Horizontal	A	270 degree

Remark: A: No degradation of performance or loss of function.

No.	Frequency (MHz)	Antenna Orientation	Observation	EUT Orientation
1	1800, 2600, 3500, 5000 ($\pm 1\%$)	Vertical/Horizontal	A	0 degree
2	1800, 2600, 3500, 5000 ($\pm 1\%$)	Vertical/Horizontal	A	90 degree
3	1800, 2600, 3500, 5000 ($\pm 1\%$)	Vertical/Horizontal	A	180 degree
4	1800, 2600, 3500, 5000 ($\pm 1\%$)	Vertical/Horizontal	A	270 degree

Remark: A: No degradation of performance or loss of function.

5.5 Test of IEC 61000-4-4

5.5.1 Test Instruments

Immunity Shield Room					
EQUIPMENT TYPE	Manufacturer	Model Number	Serial Number	Calibration Date	Calibration Due
Capacitive Clamp	EMC-Partner	CN-EFT1000	589	02/20/2024	02/19/2025
EMC Immunity Tester	EMC Partner	TRANSINT 2000	1117	02/20/2024	02/19/2025
Test Software	GenecsVer. 3.27				
Testing Site : No.163-1, Jhongsheng Rd., Xindian Dist., New Taipei City, Taiwan					

5.5.2 EUT Operating Condition

Environment:

Temperature	Humidity	Air Pressure
22.9 °C	52 %RH	1009 hpa

5.5.3 Results of Electrical Fast Transient (EFT)

Model No. : SCH4X2-A9
 Tested By : James Chou
 Tested Date : May 24, 2024
 Test Mode : Mode 2
 Basic Standard : IEC 61000-4-4
 Test Voltage : AC Input: ± 1 kV
 Signal/Comm. : ± 0.5 kV
 Polarity : Positive/Negative
 Impulse Frequency : 5 kHz
 Tr/Th : 5/50ns
 Burst : 15ms/300ms

Observation:

Test Point	Polarity	Test Level (kV)	Results
L	+/-	1	A
N	+/-	1	A
PE	+/-	1	A
L-N	+/-	1	A
L-PE	+/-	1	A
N-PE	+/-	1	A
L-N-PE	+/-	1	A
RJ45	+/-	0.5	A

Remark: A: No degradation of performance or loss of function

5.6 Test of IEC 61000-4-5

5.6.1 Test Instruments

Immunity Shield Room					
EQUIPMENT TYPE	Manufacturer	Model Number	Serial Number	Calibration Date	Calibration Due
CDN	EMC-Partner	CDN-UTP8	1502	02/20/2024	02/19/2025
EMC Immunity Tester	EMC Partner	TRANSINT 2000	1117	02/20/2024	02/19/2025
Test Software	GenecsVer. 3.27				
Testing Site : No.163-1, Jhongsheng Rd., Xindian Dist., New Taipei City, Taiwan					

5.6.2 EUT Operating Condition

Environment:

Temperature	Humidity	Air Pressure
22.9 °C	52 %RH	1009 hpa

5.6.3 Results of Surge Test

Model No. : SCH4X2-A9
 Tested By : Jacky Lin
 Tested Date : May 24, 2024
 Test Mode : Mode 2
 Basic Standard : IEC 61000-4-5
 Test Rate : 1 pulse every minute
 No. of Tests : 5 positive and 5 negative pulses
 Waveform : 1.2/50µs (8/20µs)

Observation Description

AC input line:

Test Point	Phase Angle (degree)	Polarity (+/-)	Test Level (kV)	Observation
L – N	0, 90, 180, 270	+/-	1	A
L – PE	0, 90, 180, 270	+/-	2	A
N – PE	0, 90, 180, 270	+/-	2	A

Remark: A: No degradation of performance or loss of function.

Signal line:

Test Rate : 1 pulse every minute
 No. of Tests : 5 positive and 5 negative pulses
 Waveform : 10/700µs (5/320µs)

Observation Description

Signal line:

Test Point	Phase Angle (degree)	Polarity (+/-)	Test Level (kV)	Observation
RJ45	No phase angle (degree)	+/-	1	B

Remark: B: During test, Ethernet data ping loss, but could recover automatically afterwards.

5.7 Test of IEC 61000-4-6

5.7.1 Test Instruments

CS Room					
EQUIPMENT TYPE	Manufacturer	Model Number	Serial Number	Calibration Date	Calibration Due
CDN	Teseq	CDN S751A	46649	10/13/2023	10/12/2024
CDN	Teseq	CDN M016	35821	10/13/2023	10/12/2024
CDN	TESEQ	CDN T400A	28547	10/13/2023	10/12/2024
CDN	FCC	FCC-801-M3-25A	9973	10/13/2023	10/12/2024
CDN	Teseq	CDN T8A-10	57182	06/07/2023	06/06/2024
Compact Immunity Test System	TESEQ	NSG 4070B-35	39581	10/12/2023	10/11/2024
Test Software	NSG 4070 Control Program V1.2.0				
Testing Site : No.163-1, Jhongsheng Rd., Xindian Dist., New Taipei City, Taiwan					

5.7.2 EUT Operating Condition

Environment:

Temperature	Humidity	Air Pressure
23.2 °C	53 %RH	1009 hpa

5.7.3 Results of Immunity to Conducted Disturbances (CS)

Model No. : SCH4X2-A9
 Tested By : Jim Lian
 Tested Date : May 24, 2024
 Test Mode : Mode 2
 Basic Standard : IEC 61000-4-6
 Frequency range : 0.15 MHz -10 MHz
 Field strength : 3 Vrms
 Frequency range : 10 MHz - 30 MHz
 Field strength : 3 V to 1Vrms
 Frequency range : 30 MHz - 80 MHz
 Field strength : 1 Vrms
 Modulation : 80% AM, 1 kHz Sinewave
 Frequency step : 1 % of the preceding frequency
 Dwell Time : 3 seconds
 Coupling Method : CDN-M3; CDN-T8

Cable Description	Frequency (MHz)	Observation
AC input	0.15 – 80	A

Signal Ports

Cable Description	Frequency (MHz)	Observation
RJ45	0.15 – 80	A

Remark: A: No degradation of performance or loss of function.

5.8 Test of IEC 61000-4-8

5.8.1 Test Instruments

Immunity Shield Room					
EQUIPMENT TYPE	Manufacturer	Model Number	Serial Number	Calibration Date	Calibration Due
Testing Site : No.163-1, Jhongsheng Rd., Xindian Dist., New Taipei City, Taiwan					

5.8.2 EUT Operating Condition

Environment:

Temperature	Humidity	Air Pressure
N/A	N/A	N/A

5.8.3 Result of Immunity to Power Frequency Magnetic Field

Model No. : N/A
 Tested By : N/A
 Tested Date : N/A
 Test Mode : N/A
 Basic Standard : IEC 61000-4-8
 Power Frequency : 50 Hz
 Magnetic Field : 1 A/m(r.m.s)
 Coil Orientation : X, Y, Z Axis
 Observation : N/A

Remark: N/A: There is no any sensitive part for magnetic field test. Applicable only to equipment containing susceptible to magnetic field.

5.9 Test of IEC 61000-4-11

5.9.1 Test Instruments

Immunity Shielded Room					
EQUIPMENT TYPE	Manufacturer	Model Number	Serial Number	Calibration Date	Calibration Due
AC/DC Clamp Meter	Lutron	CM-9930R	I.200121	03/08/2024	03/07/2025
EMC Immunity Tester	EMC Partner	TRANSINT 2000	1117	02/20/2024	02/19/2025
Test Software	GenecsVer. 3.27				
Testing Site : No.163-1, Jhongsheng Rd., Xindian Dist., New Taipei City, Taiwan					

5.9.2 EUT Operating Condition

Environment:

Temperature	Humidity	Air Pressure
22.9 °C	52 %RH	1009 hpa

5.9.3 Results of Voltage Dips Immunity Test

Model No. : SCH4X2-A9
 Tested By : James Chou
 Tested Date : May 24, 2024
 Test Mode : Mode 2
 Basic Standard : IEC 61000-4-11
 EUT Rated Voltage : 230 Volts.
 Reduction Voltage : 30, >95 % Ut
 Phase Angle : 0,180 degree
 Total events : 3 dropouts
 Event interval : 10 seconds

Test Power: 230Vac, 50Hz			
Environmental phenomena	Test specification (% reduction)	Duration (in periods of the rated frequency)	Observation
Voltage Interruptions	>95	250	C
Voltage dips	30	25	A
	>95	0.5	A

Test Power: 230Vac, 60Hz			
Environmental phenomena	Test specification (% reduction)	Duration (in periods of the rated frequency)	Observation
Voltage Interruptions	>95	300	C
Voltage dips	30	30	A

Remark: A: No degradation of performance or loss of function.

C: EUT shut down, it could not become normal except reinstalled by operator.

APPENDIX

Photograph of Testing General Set-up

CE Testing Set-up



ISN Testing Set-up (10Mbps & 100Mbps & 1Gb/s)

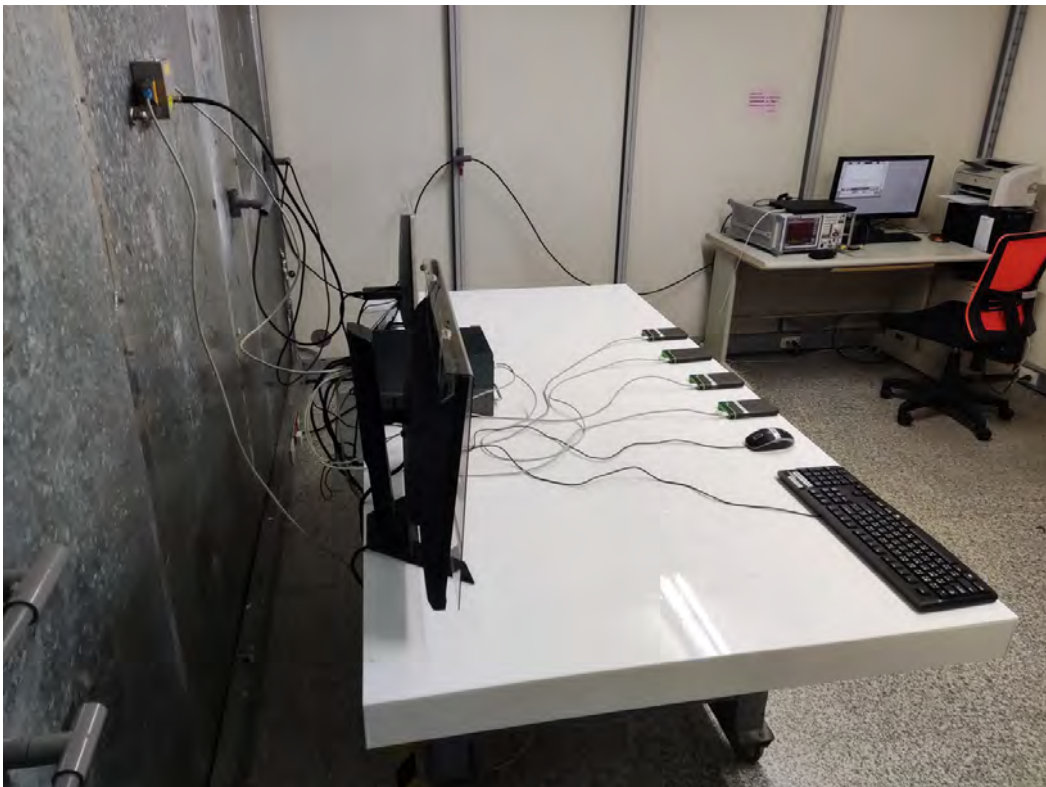

RE Testing Set-up Below 1GHz



Above 1GHz

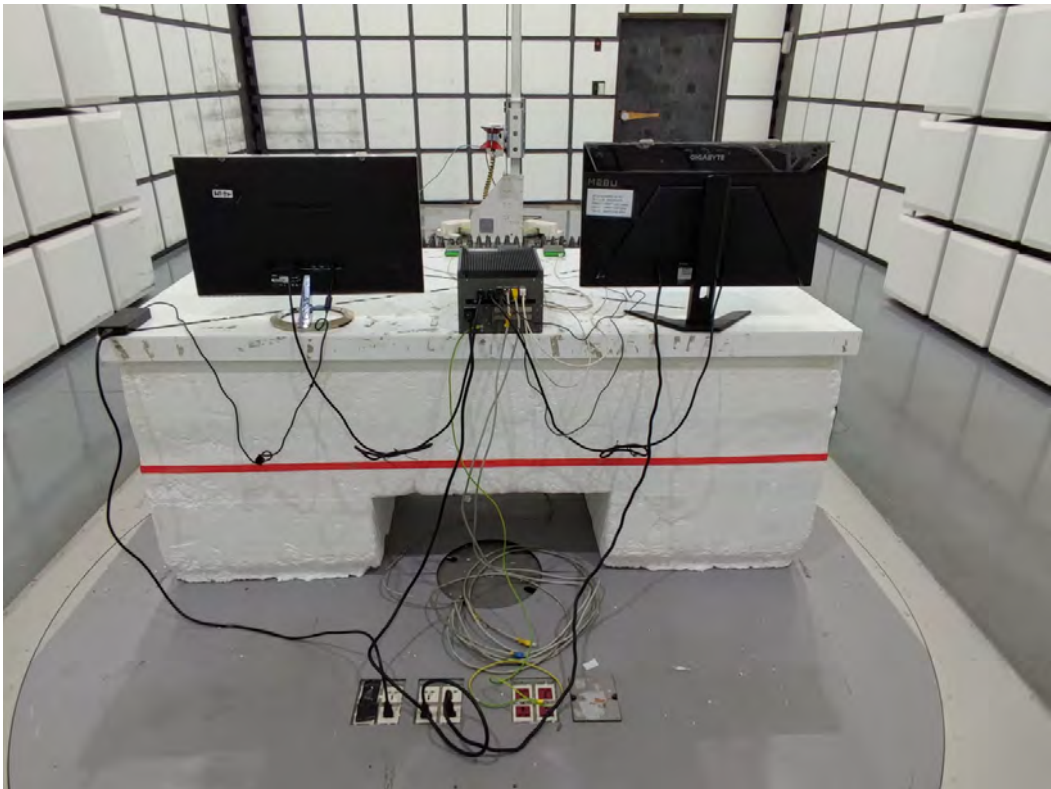
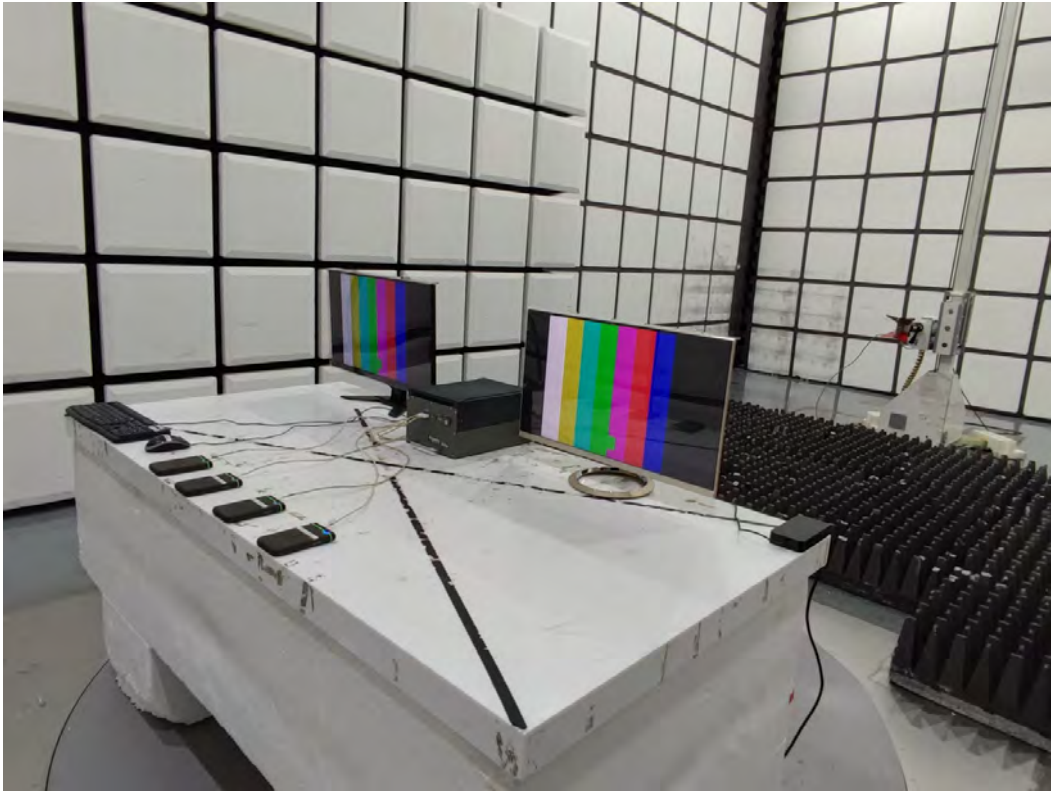

HARMONIC & FLICKER Testing Set-up



ESD Testing Set-up



RS Testing Set-up



EFT Testing Set-up

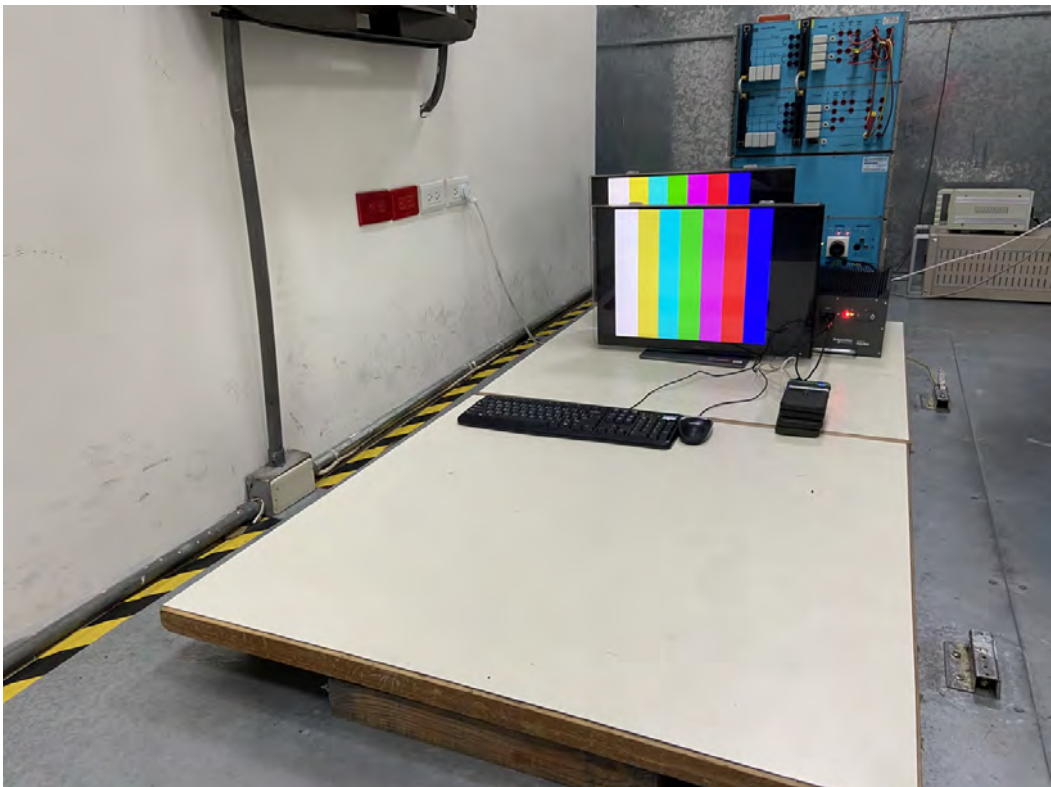

EFT For RJ45 Testing Set-up



Surge Testing Set-up

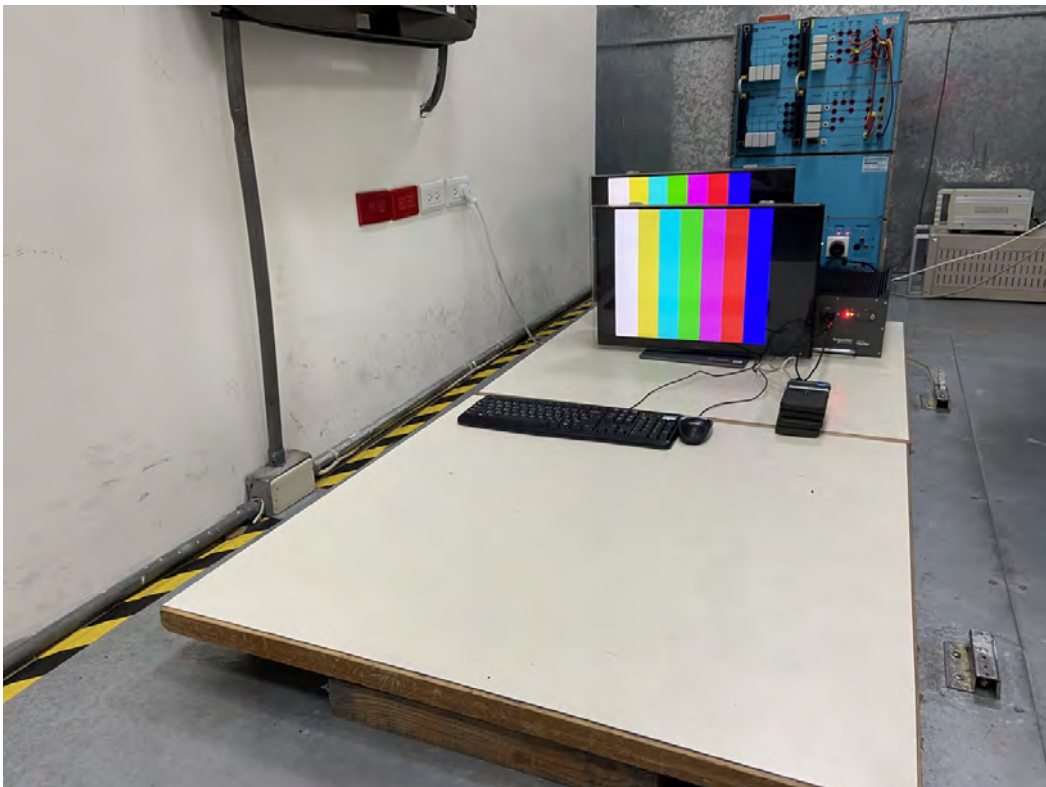

Surge For RJ45 Testing Set-up



CS Testing Set-up



CS For RJ45 Testing Set-up



DIP Testing Set-up

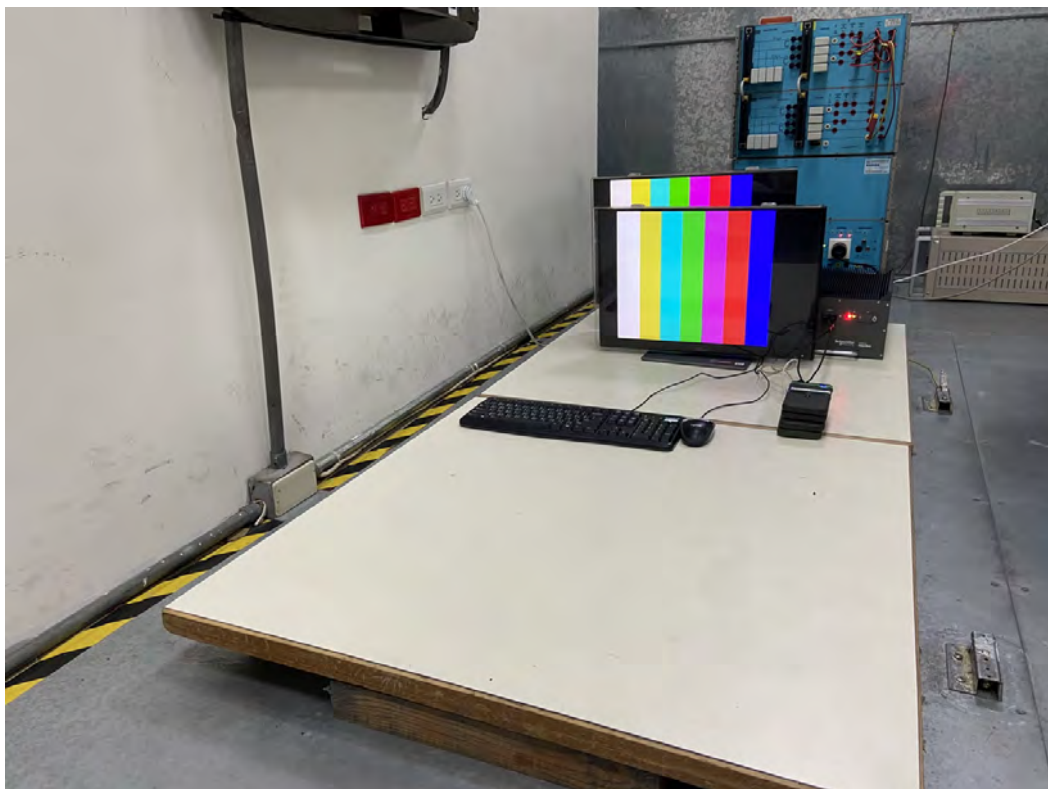

Photographs of EUT Unit Exterior





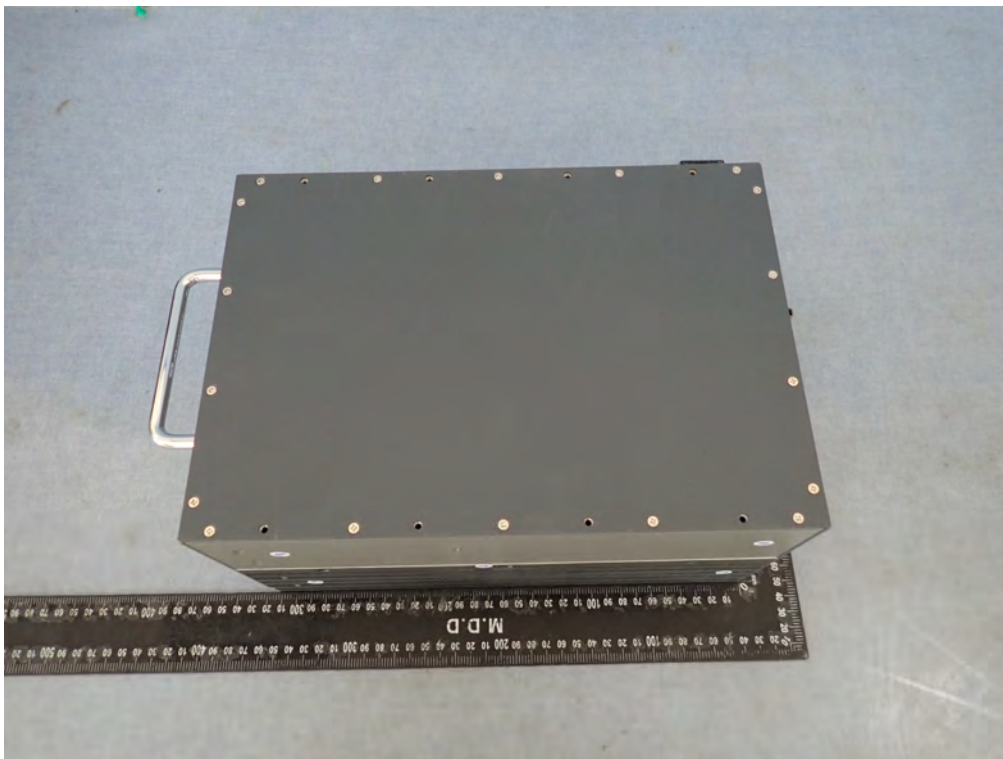
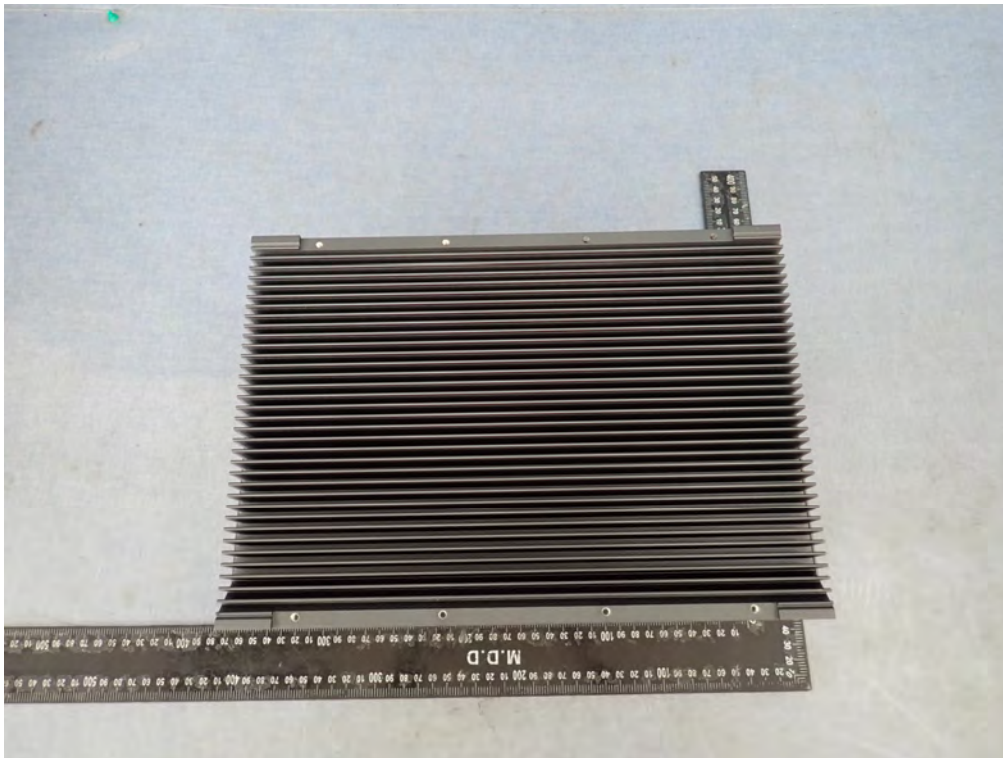

**** End of Report ****